

Scan us



Tencent  
Microblog Platform



Sina  
Microblog Platform



Micro  
Message Platform

Follow Runxin public platform  
by scanning the dual-dimensional and Wechat.



China Patent No.: ZL201510656836.1

## Multi-functional Flow Control Valve for Water Treatment Systems

18604A (Old Model No.:F118A)

17604A (Old Model No.:F118AR)

18604B (Old Model No.:F118B)

17604B (Old Model No.:F118BR)

## User Manual

Please read this manual in details  
before using the valve and keep it properly  
in order to consult in the future

0WRX.466.635



**WENZHOU RUNXIN MANUFACTURING MACHINE CO.,LTD.**

ADD: JINGER ROAD, SHATOU GROUP, LINJIANG, LUCHENG DISTRICT, WENZHOU, ZHEJIANG, CHINA

Tel: 0086-577-88630038 85956057

Fax: 0086-577-88633258

Http://www.run-xin.com

Email:sales@run-xin.com

Rev. A. 1604



Before the valve put into use ,please fill in the below content so as to help us to refer in the future.

### Softener System Configuration

Tank Size: Dia. \_\_\_\_\_mm; Height \_\_\_\_\_mm;

Resin Volume \_\_\_\_\_L; Brine Tank Capacity \_\_\_\_\_ L;

Hardness of Raw Water \_\_\_\_\_mmol/L; Pressure of Inlet Water \_\_\_\_\_MPa;

Control Valve Model \_\_\_\_\_; Number \_\_\_\_\_;

The Specification of Drain Line Flow Control \_\_\_\_\_;

The Specification of Brine Line Flow Control \_\_\_\_\_;

Injector No. \_\_\_\_\_.

Water Source: Ground-water  Filtered Ground-water  Tap Water  Other \_\_\_\_\_.

### Parameter Set

Parameter	Unit	Factory Default	Actual Value
Time of Day	h.:m.	Current Time	
Control Mode	/	A-01	
Interval Backwash Times	/	F-00	
Flow Rate Unit	/	m <sup>3</sup>	
Water Treatment Capacity	m <sup>3</sup>	10:00	
Resin Volume	L.	50	
Hardness of Raw Water	mmol/L	1.2	
Regeneration Factor	/	0.65	
Backwash Time	min.	10	
Brine & Slow Rinse Time	min.	60	
Brine Refill Time	min.	05	
Fast Rinse Time	min.	10	
Maximum Interval Regeneration Days	day	30	
Output Mode b-01/2	/	b-01	

● If there is no special requirement when product purchase, we choose 8468062 drain line flow control, 8468052 brine line flow control, and orange nozzle and green throat of injector.

## Catalogue

Notice.....	1
1.Product Overview.....	2
1.1.Main Application & Applicability.....	2
1.2.Product Characteristics.....	2
1.3.Service Condition.....	4
1.4.Product Structure and Technical Parameters.....	5
1.5.Product Installation.....	6
2.Basic Setting & Usage.....	11
2.1.The Function of PC Board.....	11
2.2.Basic Setting & Usage.....	12
3.Applications.....	14
3.1.Softener Flow Chart (Always Two Tanks in Service One Standby and Alternating Circularly).....	14
3.2.The Function and Connection of PC Board.....	15
A.Signal Output.....	15
B.Remote Handling Input.....	16
3.3.System Configuration and Flow Rate Curve.....	16
3.4. Parameter Settlement.....	19
3.5.Parameter Enquiry and Setting.....	30
3.6. Trial Running.....	22
3.7. Trouble-Shooting.....	23
3.8. Assembly & Parts.....	26
4. Warranty Card.....	32



## Notice

- To ensure normal operation of the valve, please consult with professional installation or repairing personnel before use it.
- If there are any of pipeline engineering and electric works, there must be finished by professional at the time of installation.
- Do not use the control valve with the water that is unsafe or unknown quality.
- Depending on the changing of working environment and water requirement, each parameter of softener should be adjusted accordingly.
- When the water treatment capacity is too low, please check the resin. If the reason is shortage of resin, please add; if the resin turns reddish brown or broken, please replace.
- Test water periodically to verify that system is performing satisfactorily.
- Sodium used in the water softening process should be considered as part your overall dietary salt intake. Contact doctor if you are on a low sodium diet.
- Ensure that there is solid salt all the time in the brine tank in the course of using, when this valve is used for softening. The brine tank should be added the clean water softening salts only, at least 99.5% pure, forbidding use the small salt.
- Do not put the valve near the hot resource, high humidity, corrosive, intense magnetic field or intense vibrations environment. And do not leave it outside.
- Forbidden to carry the injector body. Avoid to use injector body as support to carry the system.
- Forbidden to use the brine tube or other connectors as support to carry the system.
- Please use this product under the water temperature between 5~50°C., water pressure 0.15~0.6MPa. Failure to use this product under such conditions voids the warranty.
- If the water pressure exceeds 0.6MPa, a pressure reducing valve must be installed before the water inlet. While, if the water pressure under 0.15MPa, a booster pump must be installed before the water inlet.
- It is suggested to install PPR pipe, corrugated pipe or UPVC pipe, instead of TTLSG pipe.
- Do not let children touch or play, because carelessness operating may cause the procedure changed.
- When the attached cables of this product and transformer are changed, they must be changed to the one that is from our factory.

## 1.Product Overview

### 1.1.Main Application & Applicability

Used for softening or demineralization water treatment systems

Be suitable for Residential softening system, Ion exchange equipment RO pretreatment softening system, etc.

### 1.2. Product Characteristics

#### ● Simple structure and reliable sealing

It adopts hermetic head faces with high degree pottery and corrosion resistance for opening and closing. It combines with two tanks in serial Service, and the other tank Backwash, Brine & Slow Rinse, Brine Refill, Standby and Fast Rinse. The water treatment capacity of resin can increase by more than 50%, to maximize the exchange capacity of the resin and reduce the salt and water consumption.

#### ● Two in service one standby or one in service one standby optional

Can choose signal valve on three tanks, two in service one standby or signal valve on two tanks, one in service one standby.

#### ● Meter type

#### ● Down-flow or up-flow regeneration optional

Can choose down-flow or up-flow regeneration.

#### ● Can choose regeneration with raw water or soft water

#### ● Suitable for softening high-hardness raw water

Always two tanks are in series service and the other is standby, has backwash function and can solve the problem that the floating bed can not be suitable for high-hardness raw water with high turbidity.

#### ● Historical record can be enquired

Can enquiry day water use and 7 day water use.



#### ● Regeneration with one button

When the buttons are unlocked, press “” can start the regeneration.

#### ● Parameters save and indicate when power off

If outage overrides 3 days, the time of day indicator “12:12” will flash to remind people to reset new time of day. The other set parameters do not need to reset. The process will continue to work after power on.

#### ● Buttons lock

No operations to buttons on the controller within 1 minute, button lock indicator light on which represent buttons are locked. Before operation press and hold the “” and “”





buttons for 5 seconds to unlock. This function can avoid incorrect operation.

● **LCD screen display**

Adopt LCD display, clear and briefly.

● **Technician or manufacturer can choose language and control mode in background**

When connected with power, press and hold both “” and “” to enter into background setting menu. The menu includes choice of Chinese/English and two in service one standby /one in service one standby options.

● **Varied regeneration mode can be chosen**

Model	Name	Instruction
A-01	Down-flow Meter Immediate	Regenerate immediately when the available volume of treated water drops to zero(0).
A-03	Intelligent Down-flow Meter Immediate	Set Resin Volume, Feed Water Hardness, Regeneration Factor, the controller will calculate the System Capacity. The mode is the same with A-01.
A-11	Up-flow Meter Immediate	Regenerate immediately when the available volume of treated water drops to zero(0).
A-13	Intelligent Up-flow Meter Immediate	Set Resin Volume, Feed Water Hardness, Regeneration Factor, the controller will calculate the System Capacity. The mode is the same with A-01.

● **Signal output**

There is a signal output connector on main control board. It is for controlling external wiring. (Refer to Figure10 to Figure 12).

There are two kinds of output modes. b-01 Mode: Turn on end of standby and shut off start of standby; b-02 Mode: Signal available only intervals of regeneration cycles (motor running moment). Show as following.

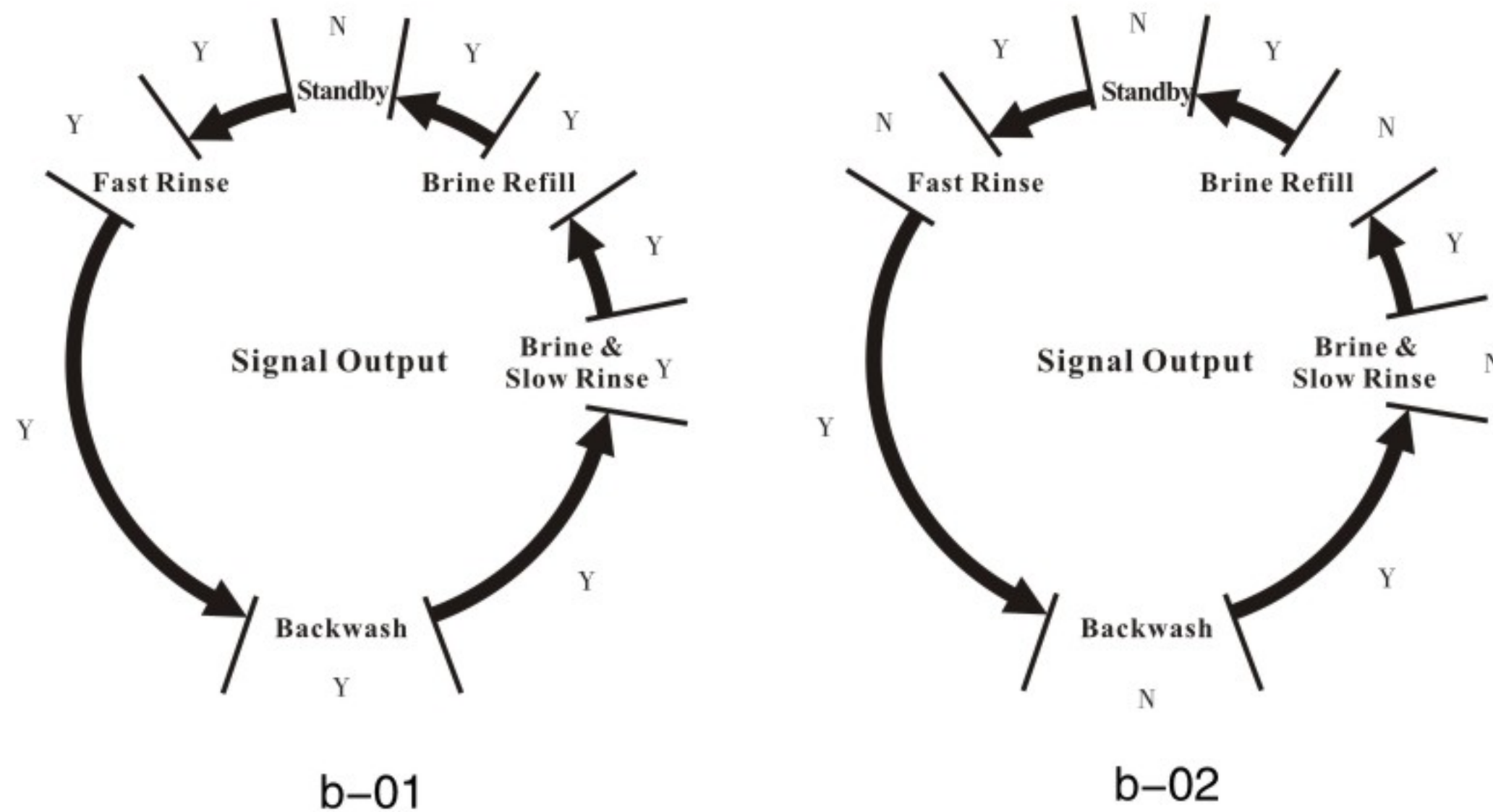

● **Remote Handling Connector**

This connector can receive 5~24VDC external signal, used together with PLC, and computer etc. to control the valve remotely. (Application refer to Figure 13).

● **Maximum interval regeneration days**

Under the situation of service reaching the setting days and the volume not yet, it could enter into regeneration process forcibly when current time is the same as regeneration time.

● **All parameters can be modified**

According to the water quality and usage, the parameters in the process can be adjusted.

**1.3. Using condition**

Runxin Valve should be used under the below conditions:

Items		Requirement
Working conditions	Water pressure	0.15MPa ~ 0.6MPa
	Water temperature	5℃ ~ 50℃
Working environment	Environment temperature	5℃ ~ 50℃
	Relative humidity	≤95% ( 25℃ )
	Electrical facility	AC100 ~ 240V/50 ~ 60Hz
Inlet water quality	Water turbidity	Up-flow regeneration < 2FTU; Down-flow regeneration < 5FTU
	Water hardness	First Grade Na+ < 6.5mmol/L; Second Grade Na+ < 10mmol/L
	Free chlorine	< 0.1mg/L
	Iron <sup>2+</sup> ( CODMn )	< 0.3mg/L < 2mg/L ( O <sub>2</sub> )

In the above table, First Grade Na<sup>+</sup> represents First Grade Na<sup>+</sup> Exchanger. Second Grade Na<sup>+</sup> represents Second Grade Na<sup>+</sup> Exchanger.

● When the water turbidity exceeds the conditions, a filter should be installed on the inlet of control valve.

● When the water hardness exceeds the conditions, the hardness of treated water can not meet the requirement of boil water(0.03mmol/L, should adopt secondary softening).



### 1.4.Product Structure and Technical Parameters

The appearance is just for reference. It is subjected to the real product.

F118A, F118B two in service one standby:

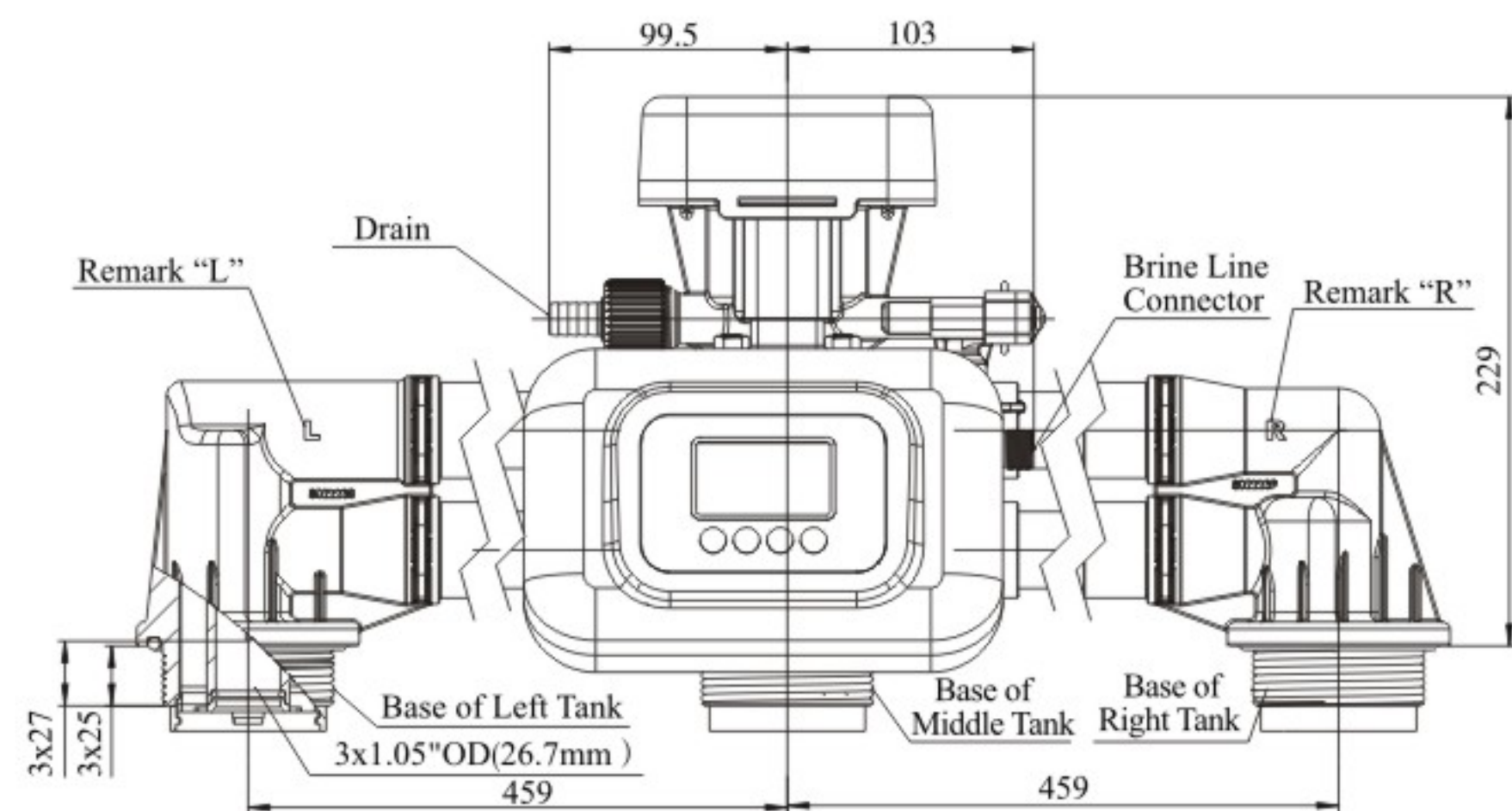

F118AR, F118BR one in service one standby

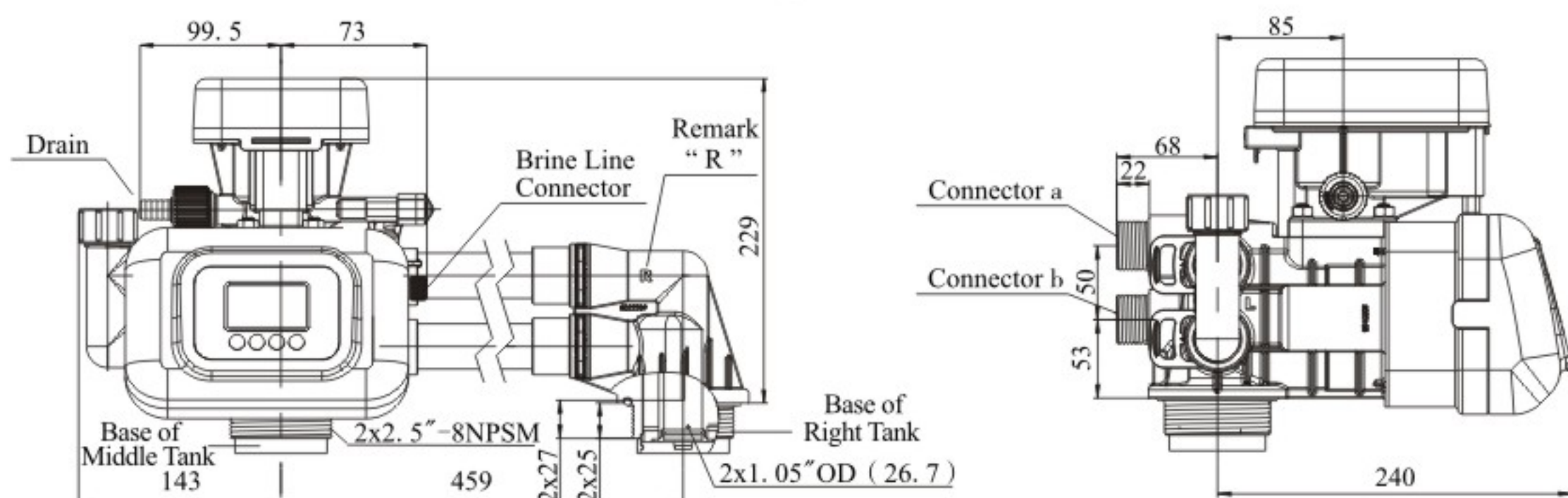

Model	Connector Size						Water for Regeneration
	Connector a	Connector b	Drain	Brine Line Connector	Base	Riser Pipe	
18604A ( F118A )	Input	Output	NPT3/4	G3/8	3x 2.5"-8NPSM	3x 1.05"OD ( φ 26.7 )	Raw water
18604B ( F118B )	Output	Input			Soft water		
17604A ( F118AR )	Input	Output			2x 2.5"-8NPSM	2x 1.05"OD ( φ 26.7 )	Raw water
17604B ( F118BR )	Output	Input			Soft water		

#### Main Technical Parameter

Water Treatment Capacity	3.0m3/h ( 0.1MPa Pressure drop ) 4m3/h ( 0.2MPa Pressure drop )
Transformer Input	AC100~240V/50~60Hz
Transformer Output	DC12V, 2A

### 1.5.Product Installation

#### A. Install notice

Before installation, read all those instructions completely. Then obtain all materials and tools needed for installation.

The installation of product, pipes and circuits, should be accomplished by professional to ensure the product can operate normally.

Perform installation according to the relative pipeline regulations and the specification of Inlet, Outlet, Drain and Brine Line Connector.

#### B. Device location

- ① The filter or softener should be located close to drain.
- ② Ensure the unit is installed in enough space for operating and maintenance.
- ③ Brine tank need to be close to softener.
- ④ The unit should be kept away the heater, and not be exposed outdoor. Sunshine or rain will cause the system damage.
- ⑤ Avoid to install the system in circumstance of Acid/Alkaline, magnetic or strong vibration, because above factors will cause the system disorder.
- ⑥ Do not install the filter or softener, drain pipeline in circumstance which temperature may drop below 5 °C, or above 50 °C.
- ⑦ One place is recommended to install the system which cause the minimum loss in case of water leaking.

#### C.Pipeline installation

##### ① Install control valve

a.As the Figure 1 shows, prepare 3 pieces of resin tanks, keep the distances between tanks about 500mm, select the riser pipe with 26.7 mm OD, glue the riser pipe to the bottom strainer and put it into the resin tank, cut off the exceeding tube out of tank top opening. Plug the riser tube in case of mineral entering.

b.Fill the resin to the tank, and the height is accordance with the design code.



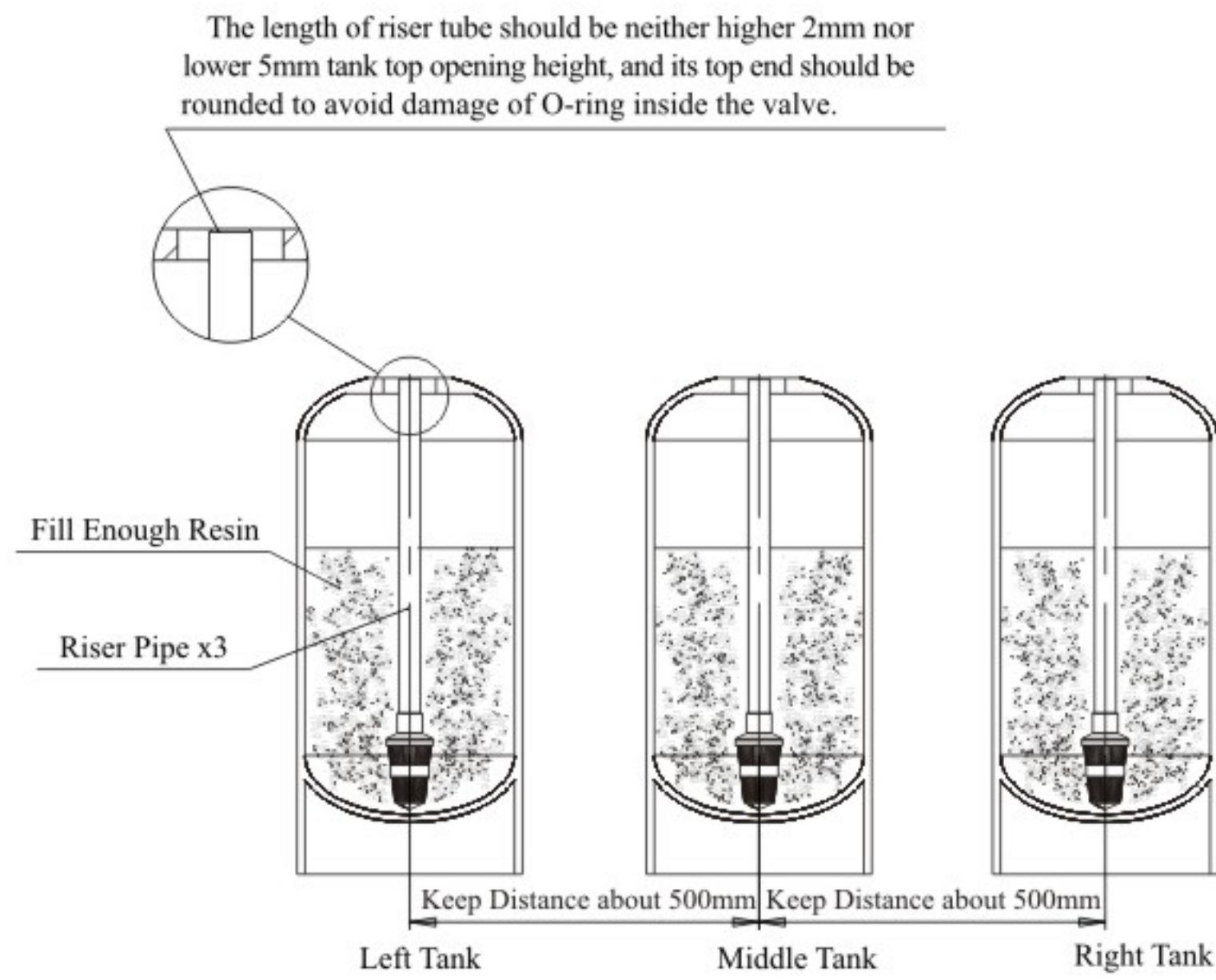

Figure 1

c. As the Figure 2 shows, screw the top strainer into the control valve. insert the riser pipe to control valve through the O-ring of base and the top strainer, then screw the control valve tightly on the tank.

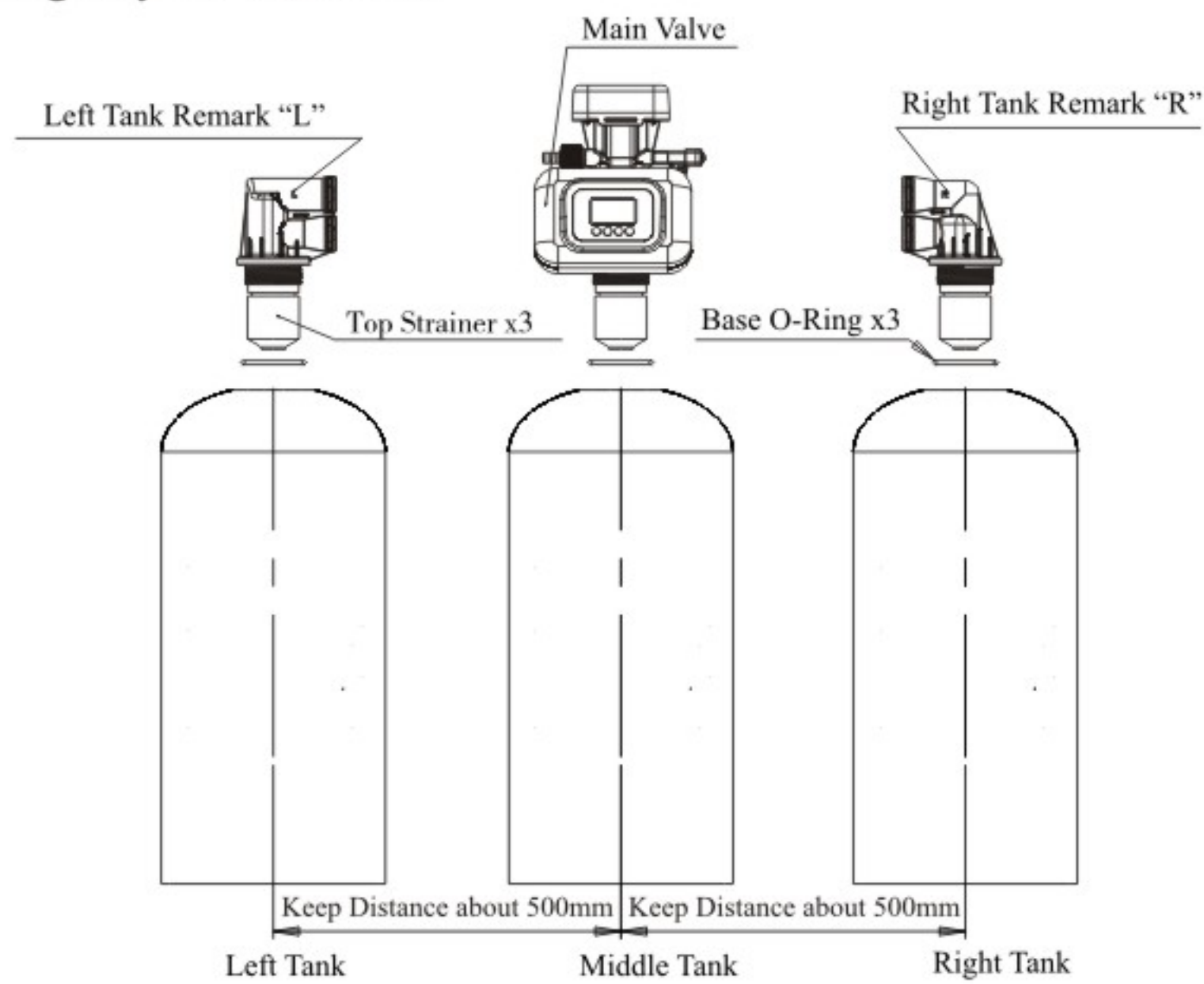

Figure 2

d. As the Figure 3 shows, insert the pipelines to the corresponding connectors on main valve then lock with clips.

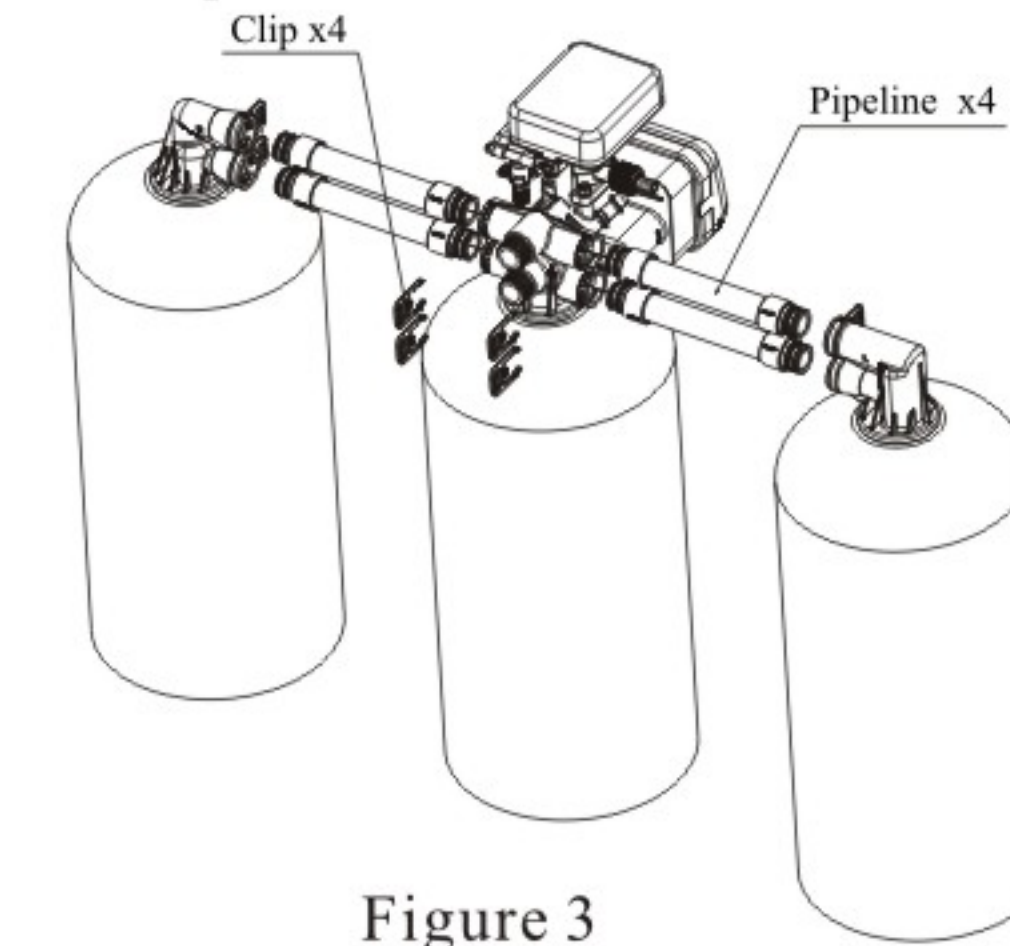

Figure 3

e. As the Figure 4 and Figure 5 show, move the left and right tanks to the middle tank, insert the pipelines to the corresponding connectors on left and right tank valve then lock with clips.

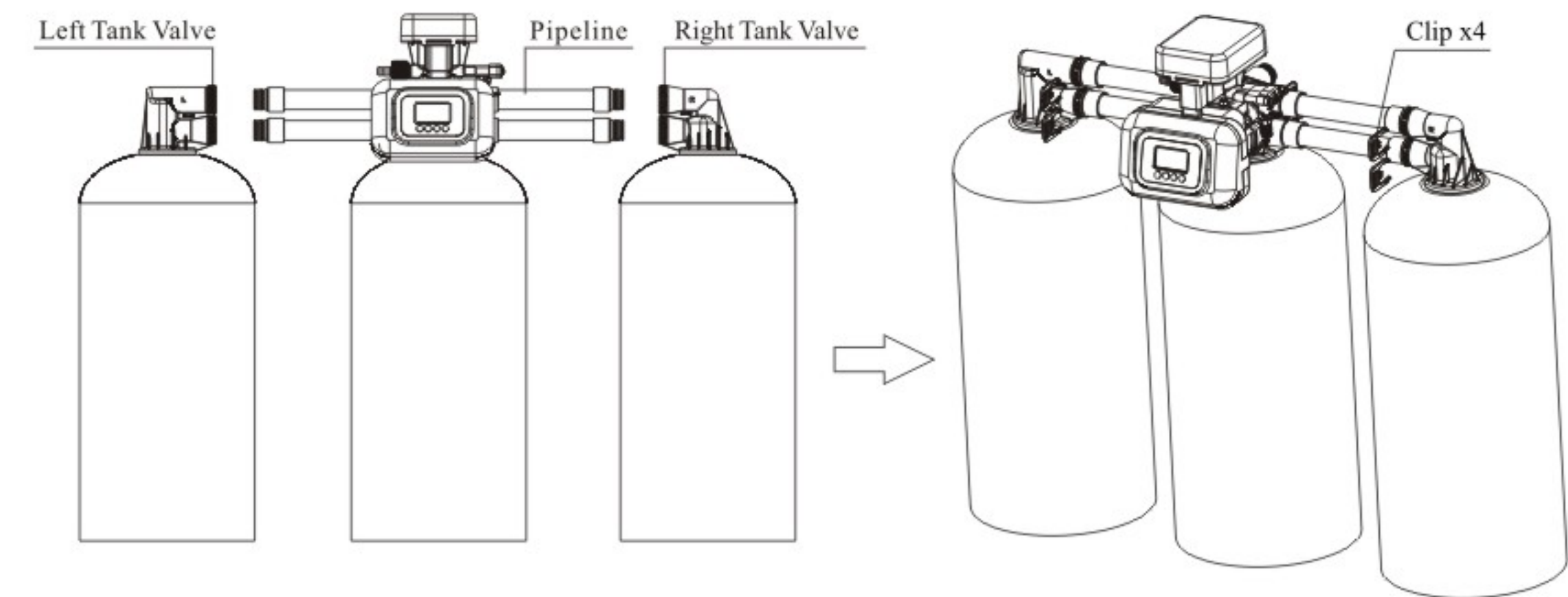

Figure 4

Figure 5

Note:

- The length of riser tube should be neither higher 2mm nor lower 5 mm tank top opening height, and its top end should be rounded to avoid damage of O-ring inside the valve.
- Avoid floccules substance together with resin to fill in the resin tank.
- Avoid O-ring inside control valve falling out while rotating it on the tank.

② Install bypass valve or flow meter

As the Figure 6 shows, put the seal washer into nut of animated connector, and screw into the inlet and outlet of control valve (Please note that the inlet and outlet when regeneration with raw water are contrary with that when regeneration with soft water.), then aim the bypass valve at the two joints, firmly press down, insert the joints into bypass valve, then lock with clips, finally, insert the sensor on flow meter wire into the slot at outlet side of the bypass valve.



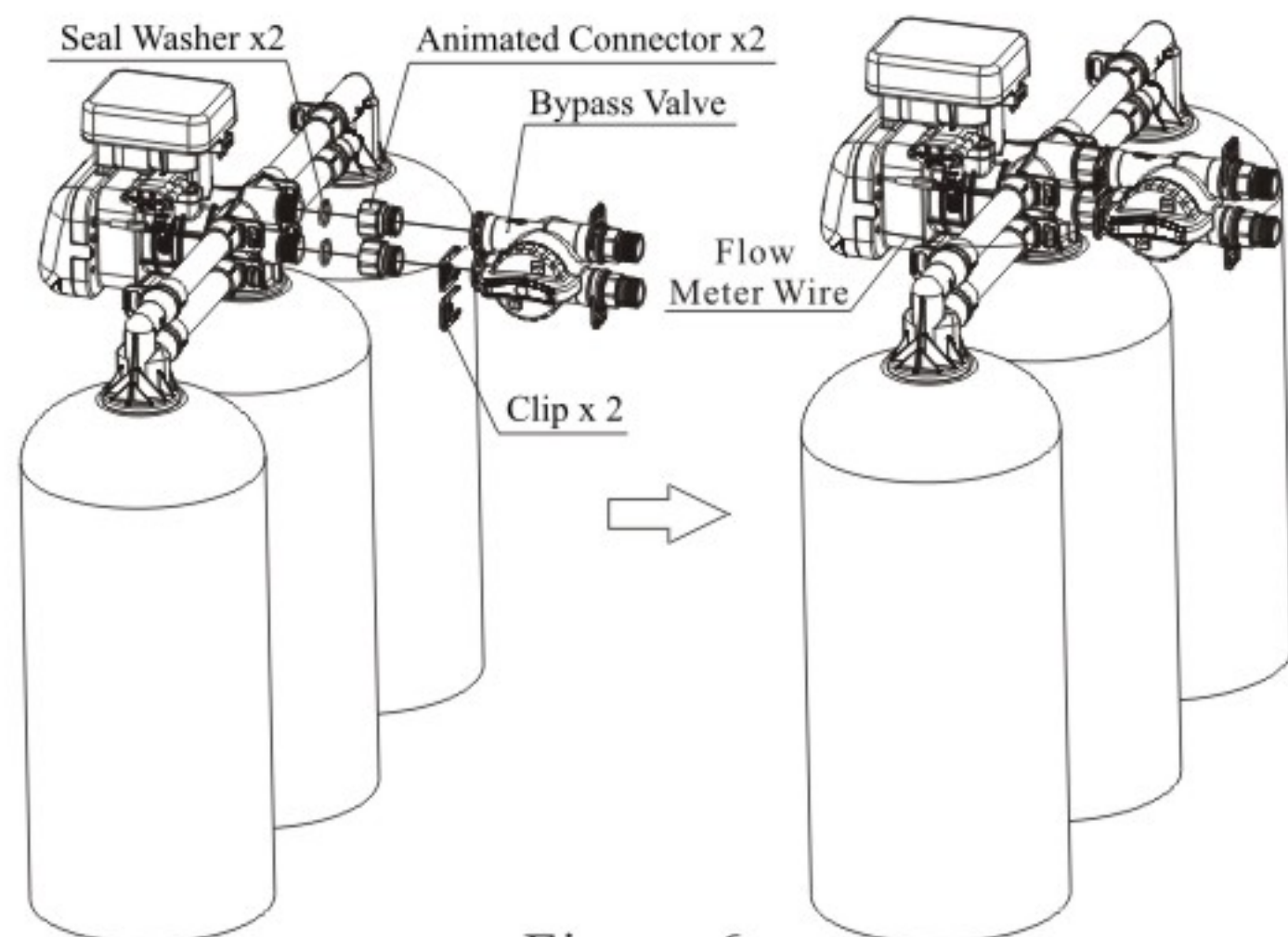

Figure 6

③ Install drain pipeline

- a. As the Figure 7 shows, put the drain line flow control into connector.
- b. Insert drain hose into drain connector.
- c. Screw the animated connector to make connector be tight with the outlet.
- d. Locate the drain hose well as the Figure 7 shows.

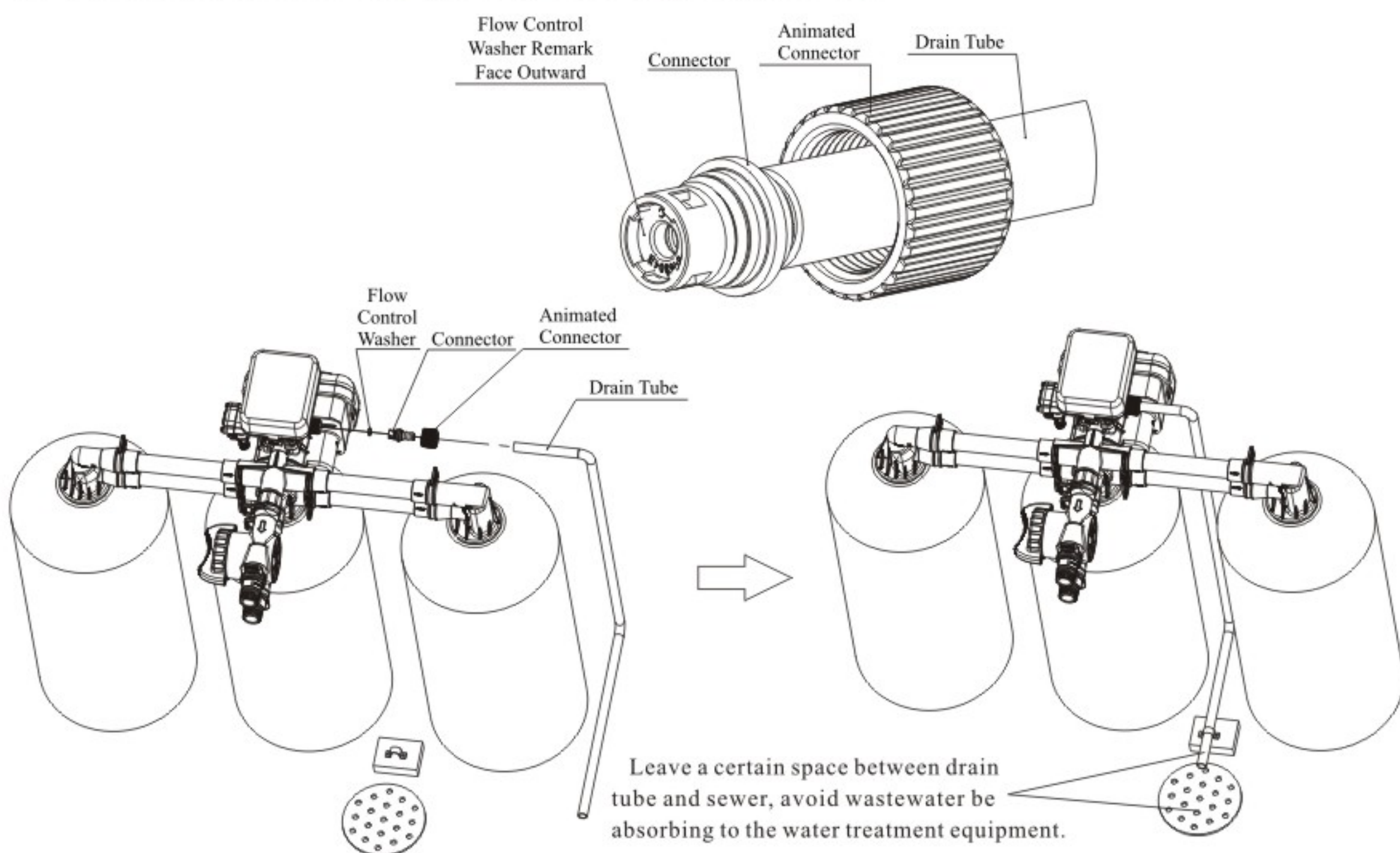

Figure 7

**Note:**

● Drain outlet should be lower than control valve, it allows being 2meters higher than control valve to arrange drain lines, and be better not longer than 3meters, or will have effect on Brine & Slow Rinse.

● Be sure not connect drain with sewer, and leave a certain space between them (Such as showed in the Figure 7.), avoid wastewater be absorbed to the water treatment equipment.

④ Connect brine tube

- a. As Figure 8 shows, insert brine line flow control into connector.
- b. Set the hex nut into brine hose.
- c. Put filter net into the tube and insert tube bushing into the end of brine tube.
- d. Tighten brine draw hose connector onto valve connector, then insert connector into brine line connector, finally, lock with the clip.
- e. Connect the other end of brine tube with the brine tank. (The liquid level controller and air-blocker should be installed in the brine tank.)

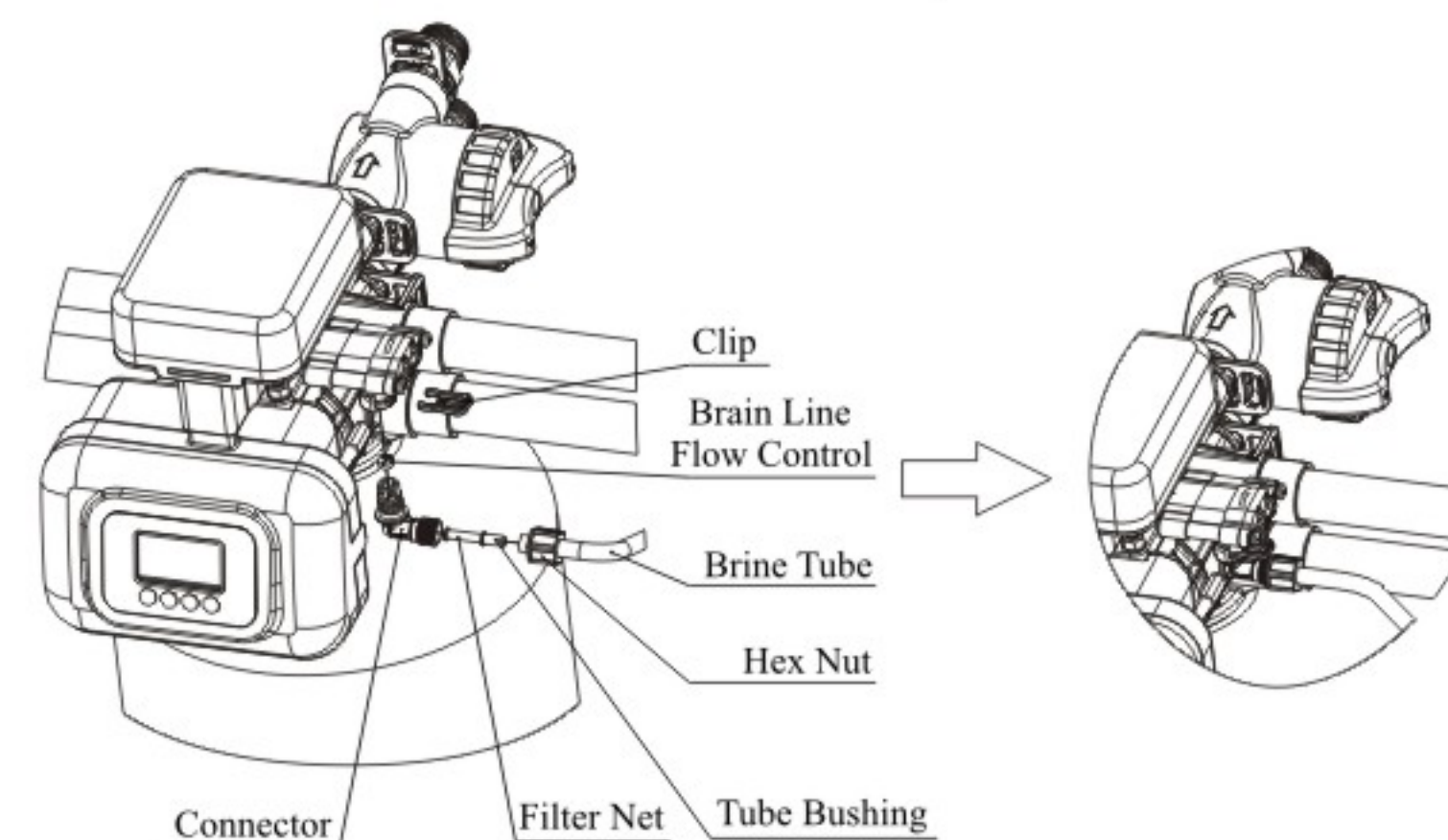

Figure 8

**Remark:** The brine tube and drain tube should not be bended or plugged.

⑤ Install electronic ball valve at outlet

Apply to two in service one standby-F118B and one in service one standby- F118BR that regeneration with soft water. The electronic ball valve is installed on the outlet of F118B or F118BR (Please note that the inlet and outlet when regeneration with raw water are contrary with that when regeneration with soft water.) it is used for controlling flow rate of outlet to ensure sufficient pressure for regeneration tank in regeneration.

The following three proposals could ensure the requested water pressure for regeneration tank without installing of electronic ball valve.

1. Make the outlet pipeline straight up at least 15 meters.
2. Install a manual adjusting ball on outlet. Adjust the outlet flow rate (the current flow rate displaying on display board) to be the same as the designed flow rate. The flow rate of raw water pump should be higher than the total flow rate of outlet flow rate and backwash flow rate.



3. Set the regeneration time at the time when rarely use water, for example for residential softener, the regeneration time could be set at 02:00 am.

## 2. Basic Setting & Usage

### 2.1. The Function of PC Board

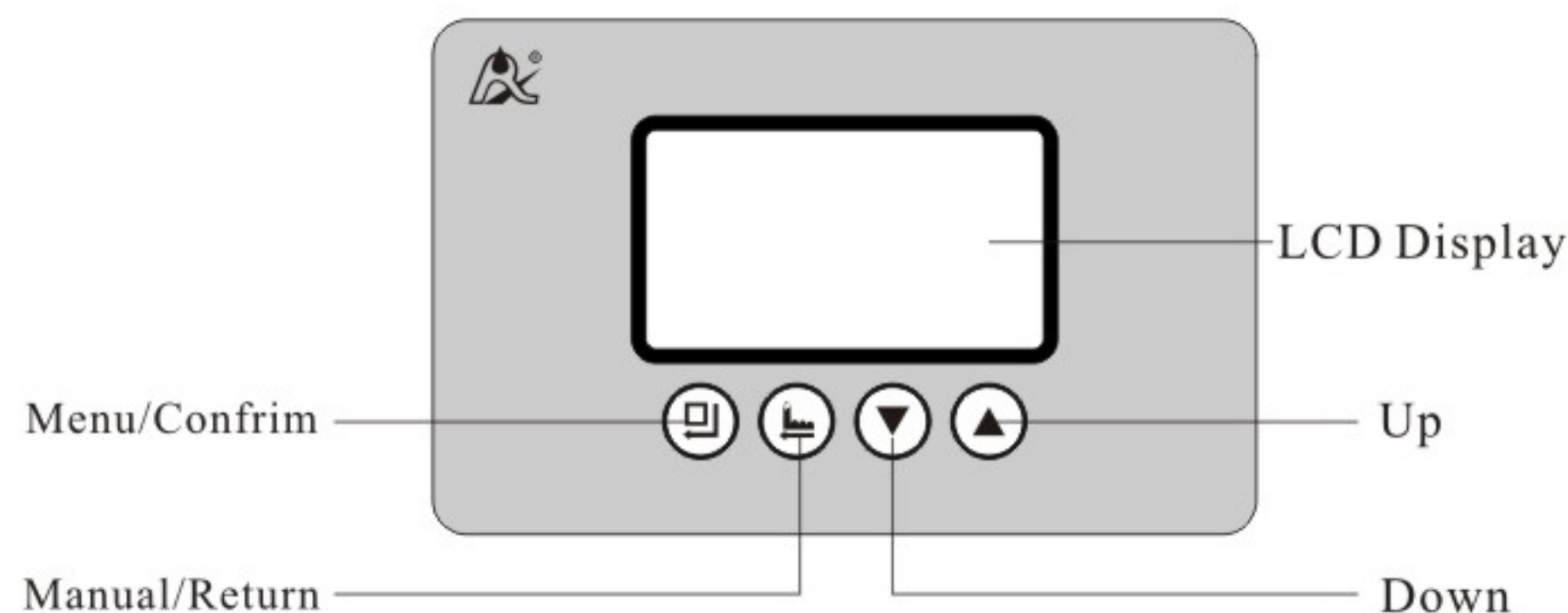

A. “” Button lock indicator

● “” Light on, indicate the buttons are locked. At this moment, press any single button will not work (Under any status, no operation in one minute, “” will light on and lock the buttons.)

● Solution: Press and hold both “” and “” for 5 seconds, the “” light off.

B. “” Manu/Confirm button

● In service mode, press “” to enter program display mode, viewing all values.

● In program display mode, press “” to enter program set mode, adjusting all values.

● Press “” after all program are set, and then the voice “Di” means all setting are success and return program display mode.

C. “” Manual/Return button

● Press “” in any status, it can proceed to next step. (Example: If the outlet water is unqualified, press “” in Service status, it will start regeneration cycles instantly; Press “” while it is in Backwash status, it will end backwash and go to Brine & Slow Rinse at once.)

● Press “” in program display mode, and it will return in Service; press “” in program set mode, and it will return program display mode.

● Press “” while adjusting the value, then it will return program display mode directly without saving value.

D. Down “” and Up “”

● In program display mode, press “” or “” to view all values.

● In program set mode, press “” or “” to adjust values.

● Press and hold both “” and “” for 5 seconds to unlock the buttons.

## 2.2. Basic Setting & Usage

A. In Service status, press “” to enter parameter set and enquiry mode.

Item	Parameter Set Range	Default Setting	Remark
Time of Day	00:00~23:59	Random	/
Regeneration Mode	A-01/03/11/13	A-01	/
Interval Backwash Times	F-00~20	F-00	Only for mode A-11/13
Flow Rate Unit	m <sup>3</sup> /gal/L	m <sup>3</sup>	/
Water Treatment Capacity	0~99.99	10.00	Only for mode A-01/11
Resin Volume	20~500	50	Only for mode A-03/13
Water Hardness	0.1~15.0	1.2	Only for mode A-03/13
Exchange Factor	0.30~0.99	0.65	Only for mode A-03/13
Backwash Time	0~99	10	/
Brine & Slow Rinse Time	0~99	60	/
Brine Refill Time	0~99	05	/
Fast Rinse Time	0~99	10	/
Maximum Interval Regeneration Days	0~40	30	/
Output Control Mode	01~02	b-01	/
Enquiry Day Water Use	/	/	/
Enquiry 7 Day Water Use	/	/	/

B. Process Display (Two in service one standby, L-M tanks are in service, R tank is standby and mode A-01 as an example.)

12:12:30 L-M tank In-Service Water Remain: 8m <sup>3</sup> Cur. F.R.: 3.86m <sup>3</sup> /h
--

Figure A

12:12:30 L-M tank In-Service R is Backwashing Remaining: 9 min.
--

Figure B

12:12:30 L-M tank In-Service R tank in B.S.R. Down-flow Remaining: 29 min.
--

Figure C

12:12:30 L-M tank In-Service Brine Refilling Remaining: 09:00 min.:sec.
--

Figure D

12:12:30 L-M tank In-Service R is standby
--

Figure E

12:12:30 L-M tank In-Service R is Fast Rinsing Remaining: 3 min.
---

Figure F

Main Valve Motor Running... -00-
--

Figure G

Regeneration Valve Motor Running... -00-
--

Figure H

12:12
-------

Figure I





**Illustration:**

- L-M tank in serial service, R tank in backwash, it shows Figure A and Figure B.
- L-M tank in serial service, R tank in brine draw, it shows Figure A and Figure C.
- L-M tank in serial service, brine refill, it shows Figure A and Figure D.
- L-M tank in serial service, R tank in standby, it shows Figure A and Figure E.
- L-M tank in serial service, R tank in fast rinse, it shows Figure A and Figure F.
- When the main valve motor running, it shows Figure G.
- When the regeneration valve motor running, it shows Figure H.
- When outage overrides 3 days and power up again, it shows Figure I.

**C.Usage**

After being accomplished installation, parameter setting and trail running by professional, the valve could be put into use. In order to ensure the quality of outlet water can reach the requirement, the user should complete the below works:

- ① Ensure that there is solid salt all the time in the brine tank in the course of using when this valve is used for softening. The brine tank should be added the clean water softening salts only, at least 99.5% pure, forbidding use the small salt and iodized salt.
- ② When the outlet water hardness is unqualified, please press “

Way of adjusting raw water hardness (under A-03/13mode):press “

When under mode A-01/11, select “cycle water treatment capacity”, and decrease the number.

The regeneration parameters have been set when control valve left factory. Generally, it does not need to reset. If you want enquiry and modify the setting, you can refer to the professional application specification.

**3.Applications**

**3.1.Softener Flow Chart (Always Two Tanks in Serial Service, One Tank Standby, Alternating Circularly)**

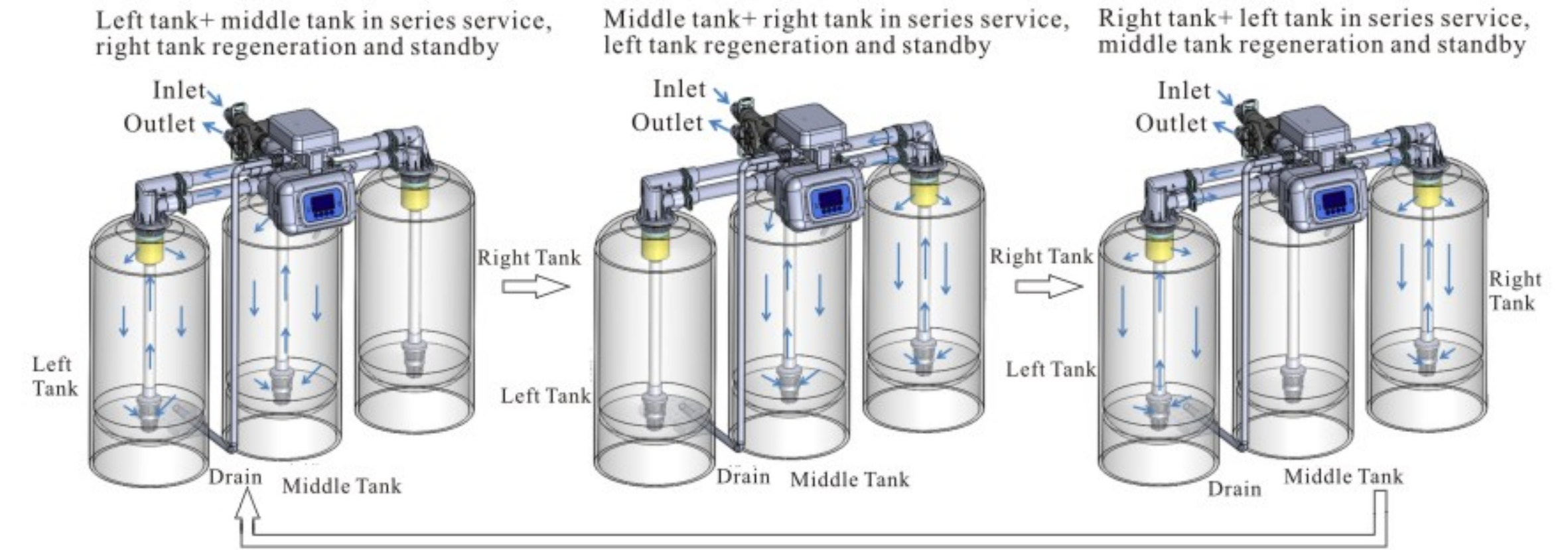

Regeneration takes the left tank and middle tank in serial service and right tank standby as sample:

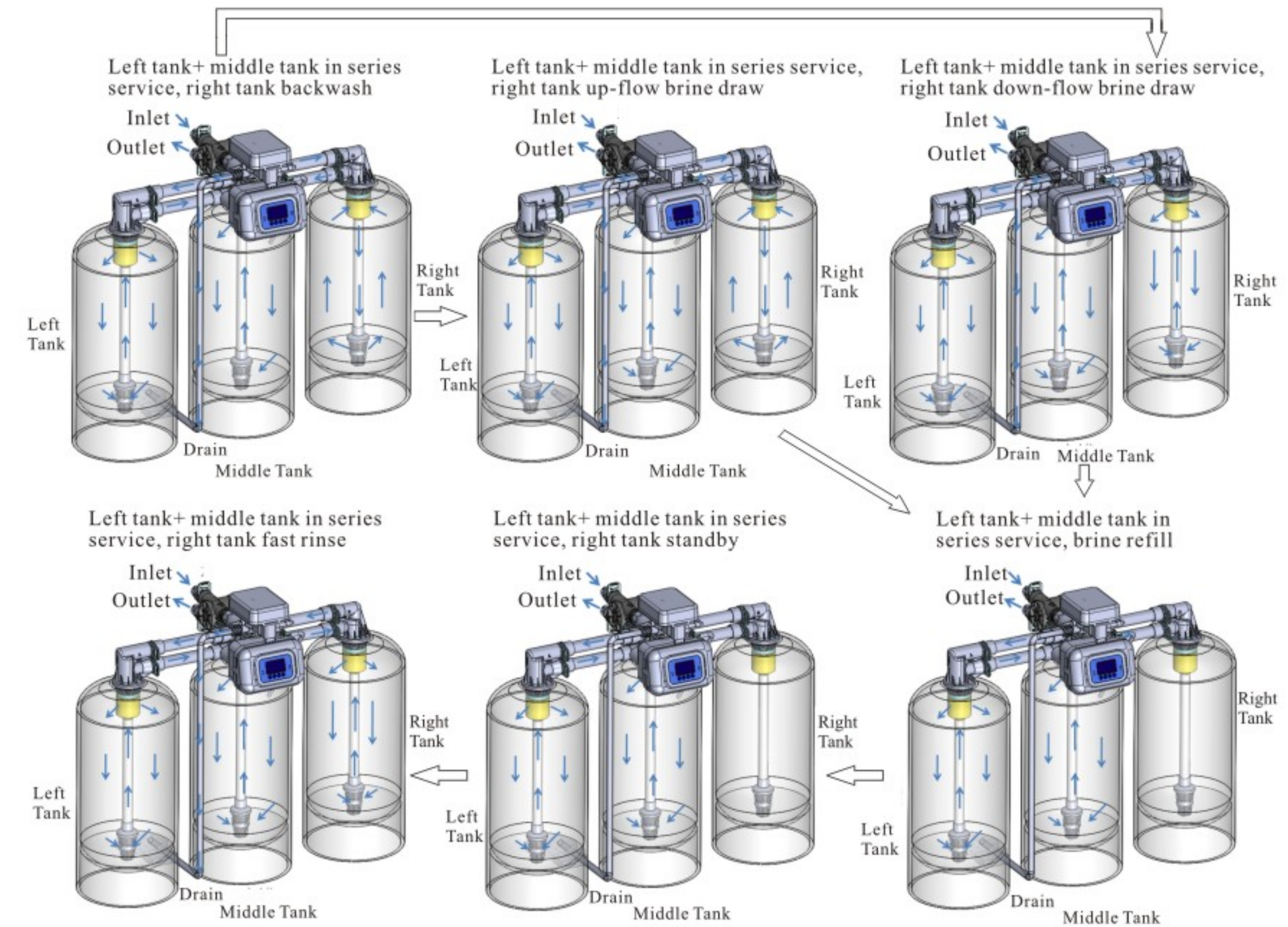



### 3.2.The Function and Connection of PC Board

Open the front cover of control valve, you will see the main control board and connection port as Figure 9:

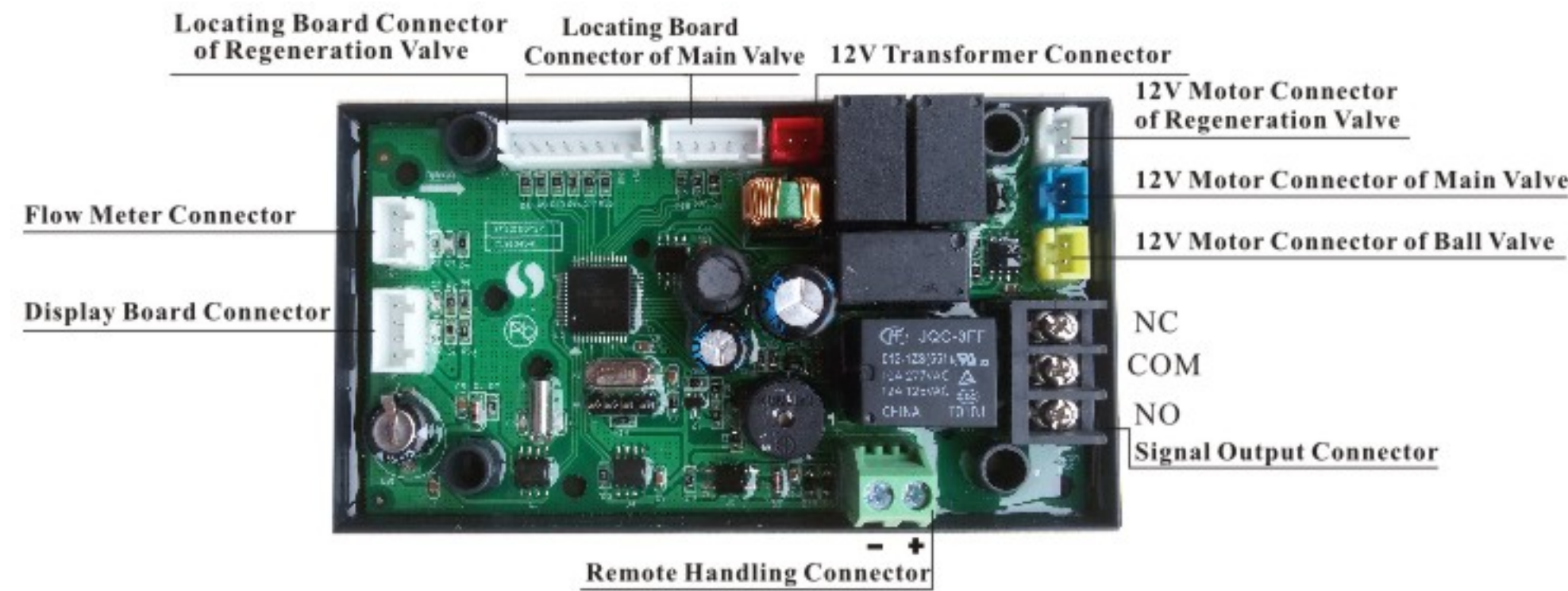

Figure 9

The main function on control board:

Function	Application	Explanation
Signal output connector b-01	Inlet pump	Increase pressure for regeneration or washing.
Signal output connector b-02	Control the inlet solenoid valve or inlet pump	When inlet pressure is high, it needs to close water inlet when valve is rotating to protect motor.
Remote handling connector	Receipt signal to make the control rotate to next circle	It is used for on-line inspection system, PC connection, and realize automatically or remote controlling valve.

#### A.Signal Output Connector

##### 1).Control Inlet Booster Pump(Set b-01)

Instruction: If inlet water pressure is less than 0.15MPa, which makes rinse drawing difficult, a booster pump is suggested to be installed on inlet. Control mode b-01. When system in regeneration cycle, booster pump is open, the wiring refer to Figure 10. IF the booster pump current us bigger than 5A, system need to install a contactor, the wiring refer to Figure 11.

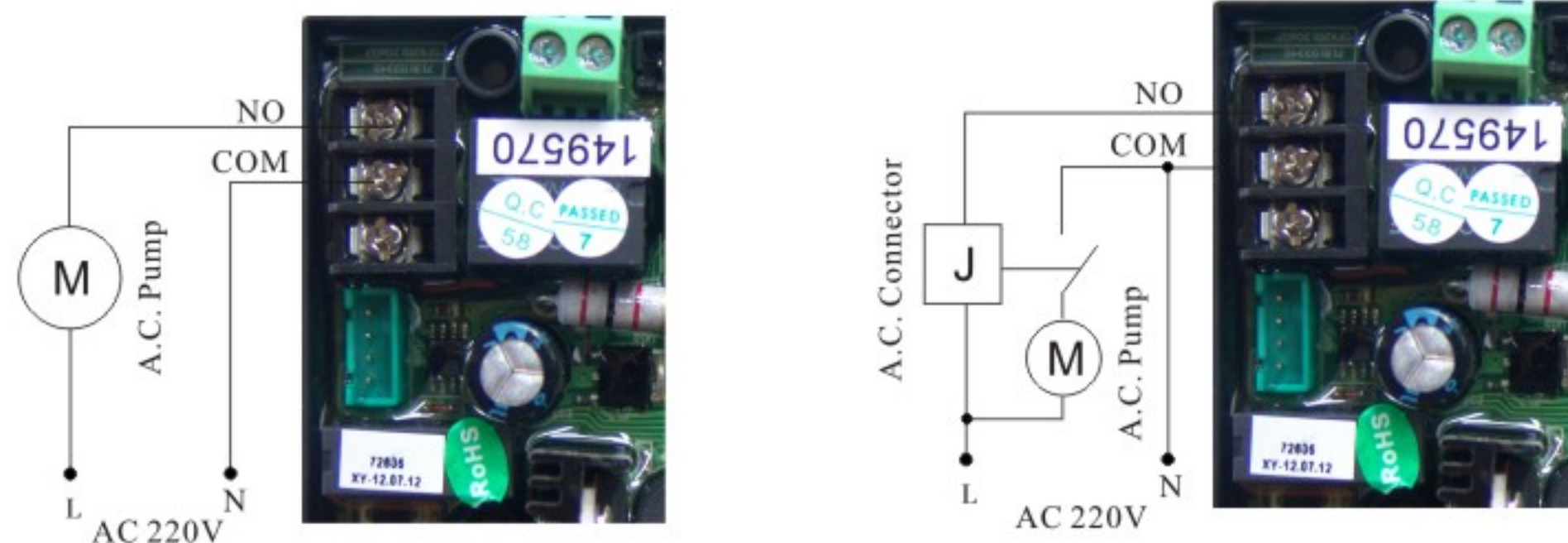

Figure10 Wiring of Booster Pump on Inlet Figure11 Wiring of Booster Pump on Inlet

##### 2).Solenoid Valve on Inlet ( Set b-02)

Instruction: When inlet pressure exceeds 0.6MPa, in order to ensure the valve working positions switching properly, it needs to install a solenoid valve on inlet or control inlet pump. When valve is in working positions switching, shut off solenoid valve or inlet pump so that valve switching without pressure, when valve arrives at working position, open solenoid valve or inlet pump. Control mode is b-02. Pressure relieved when valve switching, the wiring refer to Figure 12.

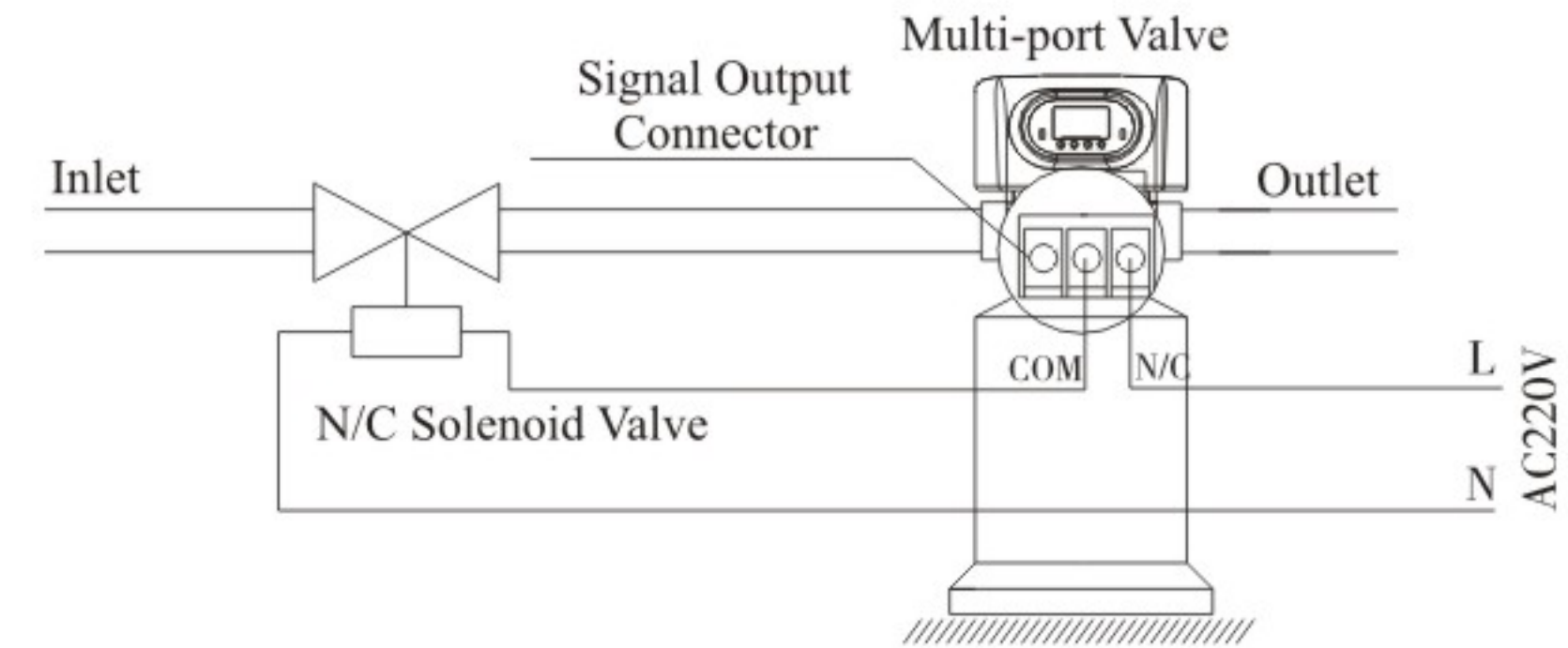

Figure 12 Wiring of Solenoid Valve on Inlet

#### B.Remote Handling Connector

Online TDS meter monitors treated water other than a flow meter, or PLC controls the regeneration time. When the controller receives a contact closure from above instruments, regeneration begins. The wiring refers to Figure 13.

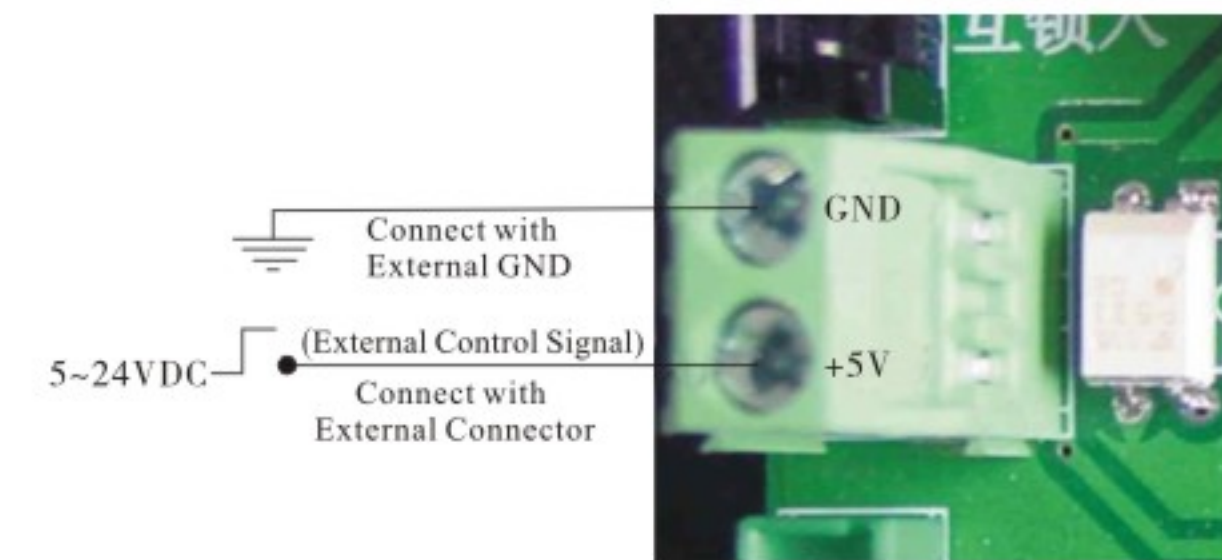

Figure13 Wiring of Remote Input

### 3.3.System Configuration and Flow Rate Curve

A.Product configuration with tank, resin volume, brine tank and injector.

Tank Diameter (mm)	Resin Volume (L)	Water Capacity (m <sup>3</sup> /h)	Brine Tank (L)	Minimum Salt Consumption for Regeneration (Kg)	Injector Nozzle/Throat
Φ250×1390	40	1.5	100	6.0	White/White
Φ300×1650	70	2.0	100	10.5	Red/Red
Φ350×1650	100	2.5	200	15.0	Green/Green
Φ400×1650	120	3.5	200	18.0	Orange/Green



Φ450×1650	150	4.5	300	22.5	Orange/Green
-----------	-----	-----	-----	------	--------------

Attention: The flow rate calculation is based on linear velocity 25m/hr; the minimum salt consumption for regeneration calculation is based on salt consumption 150g / L (Resin).

**B.Flow Rate Characteristic**

**(1).Pressure-flow Rate Curve**

Two in Service One Standby:

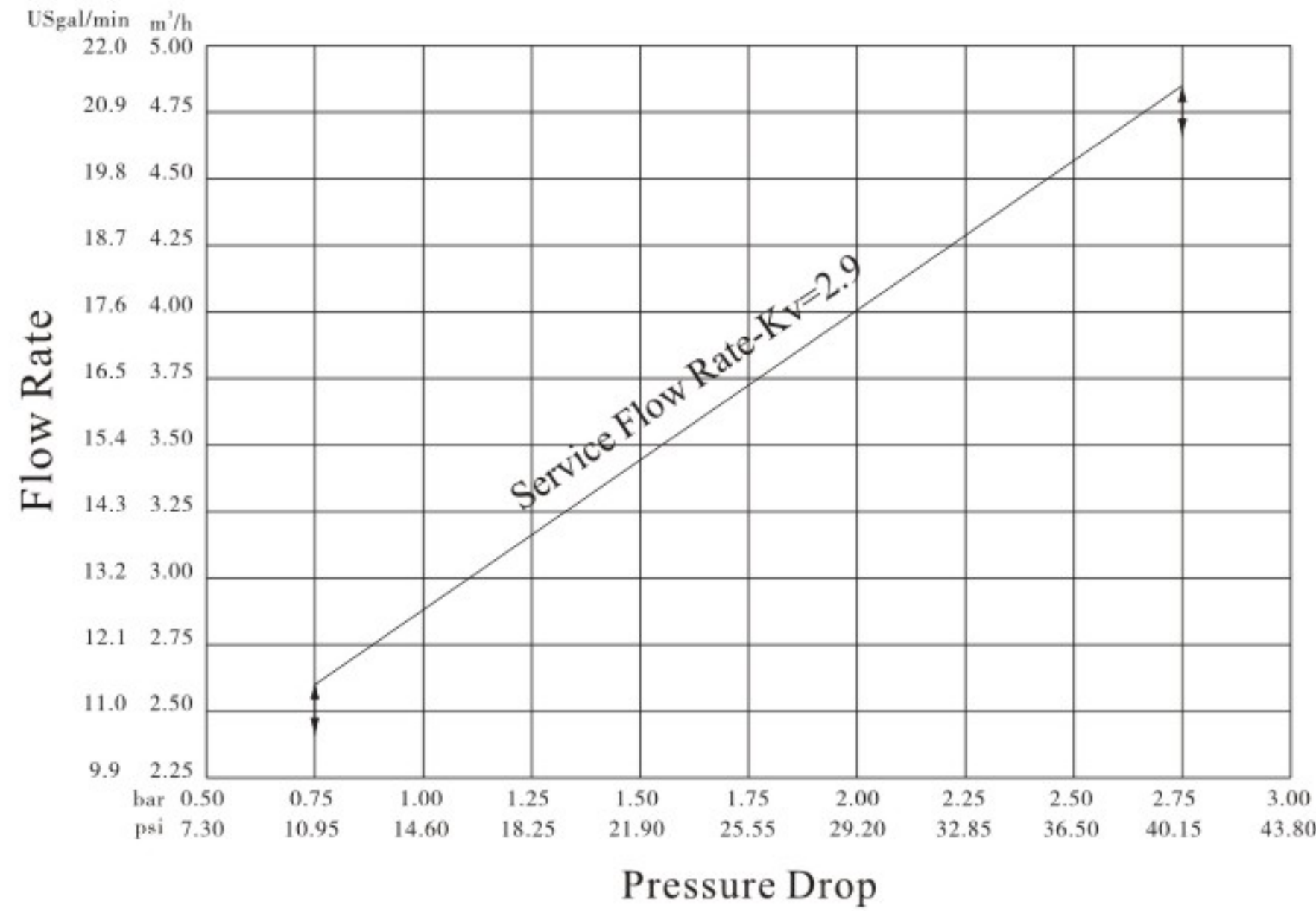

One in Service One Standby:

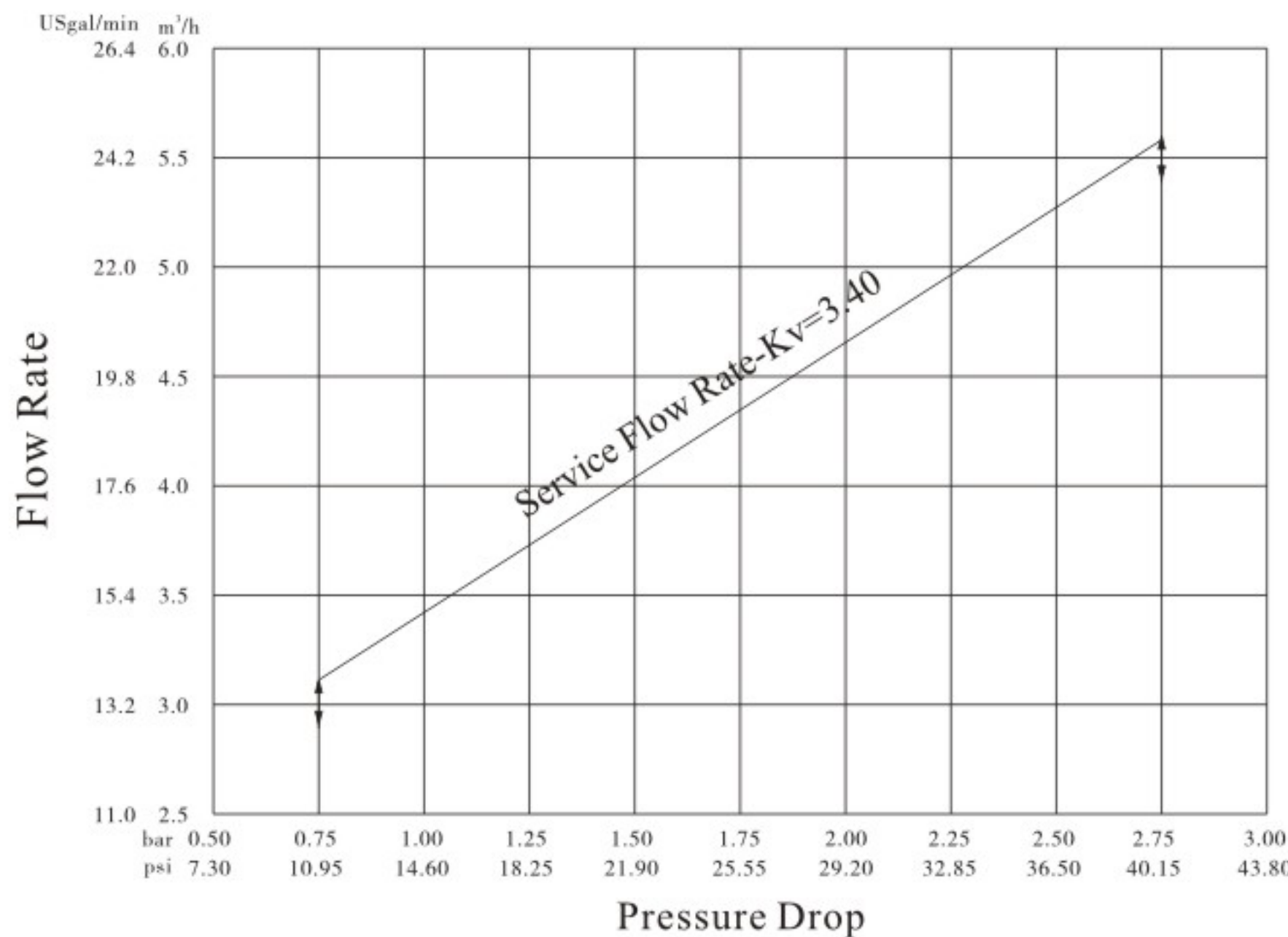

**(2).Injector Parameter Table**

Inlet Pressure MPa	Flow Rate on Injector (L/min)								
	630X series color of Nozzle/Throat								
	Pink/Pink	Yellow/Yellow	Blue/Blue	White/White	Black/Black	Purple/Purple	Red/Red	Green/Green	Orange/Green
0.15	1.74	2.26	2.80	3.46	3.76	4.19	4.60	5.78	6.44
0.20	2.02	2.60	3.28	3.98	4.28	4.80	5.22	6.71	7.41
0.25	2.21	2.92	3.68	4.45	4.79	5.40	5.89	7.50	8.00
0.30	2.43	3.14	3.94	4.83	5.18	5.87	6.40	8.18	8.89
0.35	2.64	3.37	4.23	5.22	5.53	6.2	6.91	8.77	9.59
0.40	2.82	3.58	4.50	5.60	5.77	6.65	7.27	9.32	10.1
0.45	2.99	3.86	4.81	5.86	6.15	7.00	7.55	9.77	10.6

**(3).Parameter Table for Brine Line Flow Control**

Number	8468076	8468075	8468057	8468056	8468052	8468053	8468054	8468055
Flow rate L/min	0.30	0.58	0.68	1.13	1.52	2.83	4.9	5.6

**(4).Parameter Table for Drain Line Flow Control**

Number	8468064	8468043	8468042	8468060	8468061	8468045	8468044	8468062	8468063
Flow rate L/min	3.33	4.31	7.15	7.64	10.82	15.96	18.5	24.97	30.64

**(5).Configuration for Standard Injector and Drain Line Flow Control**

Tank Diameter mm	Regeneration Mode	Color of Nozzle/Throat	Total Flow Rate on Injector L/min	Flow Rate of Slow Rinse L/min	Number of BLFC	Number of BLFC
200	Up-flow	Pink/Pink	2.43	1.28	8468076, 8468075, 8468057, 8468056, 8468052	8468042
	Down-flow	Yellow/Yellow	3.14	1.88	All sizes except 8468054, 8468055	
225	Up-flow	Pink/Pink	2.43	1.28	8468076, 8468075, 8468057, 8468056, 8468052	8468060
	Down-flow	Blue/Blue	3.94	2.63	All sizes except 8468054, 8468055	
250	Up-flow	Yellow/Yellow	3.14	1.88	All sizes except 8468054, 8468055	8468061
	Down-flow	White/White	4.83	3.25		
300	Up-flow	Blue/Blue	3.94	2.63	All sizes except 8468054, 8468055	8468045
	Down-flow	Red/Red	6.4	4.3		
325	Up-flow	Black/Black	5.18	3.39	All sizes except 8468055	8468045
	Down-flow	Green/Green	8.18	5.68	All sizes	
350	Up-flow	Purple/Purple	5.87	4.17	All sizes	8468044
	Down-flow	Green/Green	8.18	5.68		



400	Up-flow	Red/Red	6.4	4.3	All sizes	8468062
	Down-flow	Orange/Green	8.89	6.5		
450	Up-flow	Green/Green	8.18	5.68	All sizes	8468063
	Down-flow	Orange/Green	8.89	6.5		

**Note:** Above configuration and related curve for reference only.

### 3.4.Parameter Settlement

#### ① Service time T1

Water treatment capacity :

$$Q=1.5 \times V_R \times K \div Y_D \quad (m^3)$$

Hardness of Inlet Water, mmol/L.

Exchange factor, (mmol/L) 400~1000. Down-flow regeneration, take 400~750. Up-flow regeneration, take 450~1000. If the inlet water hardness is higher, the factor is smaller.

Resin volume (m<sup>3</sup>).

#### ② Backwash time T2

It is subject to the turbidity of inlet water. Generally, It is suggested to be set 10~15 minutes. The higher the turbidity is, the longer backwash time can be set. However, if the turbidity is more than 5FTU, it should be better to install a filter in front of the exchanger.

#### ③ Brine& slow rinse time T3

$$T3=(40\sim50) \times H_R \quad (min)$$

Generally, T3=45H<sub>R</sub> (min)

In this formula, H<sub>R</sub>——the height of resin in exchange tank (m)

#### ④ Brine refill time T4

$$T4=0.34 \times V_R \div \text{Brine refill speed} \quad (min)$$

In this formula, V<sub>R</sub>——Resin volume (m<sup>3</sup>)

#### ⑤ Fast rinse time T5=12×H<sub>R</sub> (min)

Generally, the water for fast rinse is 3~6 times of resin volume. It is suggested to be set 10~16 minutes, but subject to the outlet water reaching the requirement.

#### ⑥ Exchange factor

$$\text{Exchange factor} = E / (k \times 1000)$$

In this formula, E——Resin working exchange capability (mol/m<sup>3</sup>), it is related to the quality of resin. Down-flow regeneration, take 800~900. Up-flow regeneration,

take 900~1200.

K——Security factor, always take 1.2~2. it is related to the hardness of inlet water: the higher the hardness is, the bigger the K is.

⑦ Regeneration time: The whole cycle for generation is about two hours. Please try to set up the regeneration time when you don't need water according to the actual situation.

The calculation of parameters for each step is only for reference, the actual proper time will be determined after adjusting by water exchanger supplier. This calculation procedure of softener is only for industrial application; it is not suitable for small softener in residential application.



### 3.5.Parameter Enquiry and Setting

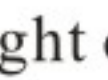
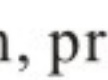

#### (1).Parameter enquiry and setting flow chart

When “” light on, press and hold both “” and “” for 5 seconds to lift the button lock statues; take the regeneration mode A-01 as sample and the parameter enquiry and setting are as follows:

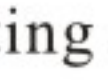





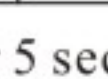





































































#### (2).Steps of parameter enquiry and setting(Take A-01 mode as a sample)

When the buttons are unlocked, press “” can enter setting and enquiry and press “” or “”.

Item	Steps	Symbol
	Before enquiry and setting ,when “  ”light up ,press “  ” and “  ” for 5 seconds to unlock the valve .	



Time of Day	1. Press “  ” to enter into program display mode, select “Set the Time of Day”; 2. Press “  ”, when symbol shows as the right figure, both “  ” and hour value “12” flash, press “  ” or “  ” to adjust the value; 3. Press “  ” again, both “  ” and minute value “10” flash, through “  ” or “  ” to adjust the minute value; 4. Press “  ” then you will hear a sound and finish adjustment.	Set Time of Day 12:10
Regeneration Mode	1. In menu status, press “  ” or “  ”, select “Set Regen. Mode”; 2. Press “  ”, when symbol shows as the right figure, press “  ” or “  ” to select the one you need; 3. Press “  ”, then you will hear a sound and finish adjustment.	Set Regen. Mode A-01 Immediate Down-flow
Flow Rate Unit	1. In menu status, press “  ” or “  ”, select “Set Flow Rate Unit”; 2. Press “  ”, when symbol shows as the right figure, press “  ” or “  ” to select the one you need; 3. Press “  ”, then you will hear a sound and finish adjustment.	Set Flow Rate Unit ● m <sup>3</sup> ○ gal ○ L
Water Treatment Capacity	1. In menu status, press “  ” or “  ”, select “Set Capacity”; 2. Press “  ”, when symbol shows as the right figure, and “10” flash, press “  ” or “  ” to adjust the value; 3. Press “  ”, when “00” flash, press “  ” or “  ” to adjust the value; 4. Press “  ”, then you will hear a sound and finish adjustment.	Set Capacity 10.00m <sup>3</sup>
Backwash Time	1. In menu status, press “  ” or “  ”, select “Set Backwash Time”; 2. Press “  ”, when symbol shows as the right figure, press “  ” or “  ” to adjust the backwash time; 3. Press “  ”, then you will hear a sound and finish adjustment.	Set Backwash Time 10 min.
Brine & Slow Rinse Time	1. In menu status, press “  ” or “  ”, select “Set B.S.R. Time”; 2. Press “  ”, when symbol shows as the right figure, press “  ” or “  ” to adjust the brine & slow rinse time; 3. Press “  ”, then you will hear a sound and finish adjustment.	Set B.S.R. Time 60 min.
Brine Refill Time	1. In menu status, press “  ” or “  ”, select “Set B. R. Time”; 2. Press “  ”, when symbol shows as the right figure, press “  ” or “  ” to adjust the brine refill time; 3. Press “  ”, then you will hear a sound and finish adjustment.	Set B.R. Time 05:00 min. Sec.
Fast Rinse Time	1. In menu status, press “  ” or “  ”, select “Set Fast Rinse Time”; 2. Press “  ”, when symbol shows as the right figure, press “  ” or “  ” to adjust the fast rinse time; 3. Press “  ”, then you will hear a sound and finish adjustment.	Set Fast Rinse Time 10 min.
Maximum Interval Regeneration Days	1. In menu status, press “  ” or “  ”, select “Max Days for Regen.”; 2. Press “  ”, when symbol shows as the right figure, press “  ” or “  ” to adjust the maximum interval regeneration days; 3. Press “  ”, then you will hear a sound and finish adjustment.	Max Days for Regen. 30 days

Signal Output Mode	1. In menu status, press “  ” or “  ”, select “Signal Output Mode”; 2. Press “  ”, when symbol shows as the right figure, press “  ” or “  ” to adjust the signal output mode; 3. Press “  ”, then you will hear a sound and finish adjustment.	Signal Output Mode b-01
Enquiry Day Water Use	1. In menu status, press “  ” or “  ”, select “Day Water Use”; 2. Press “  ” to enquiry the water use, and the symbol shows as the right figure; 3. Press “  ” to turn back.	Day Water Use 1.20m <sup>3</sup>
Enquiry 7 Day Water Use	1. In menu status, press “  ” or “  ”, select “7 Day Water Use” 2. Press “  ” to enquiry the water use in last 7 days, and the symbol shows as the right figure; 3. Press “  ” to turn back.	7 Day Water Use Day 1: 1.10m <sup>3</sup> Day 2: 1.20m <sup>3</sup> Day 3: 1.00m <sup>3</sup> ↓

### 3.6. Trial Running

After installing the multi-functional flow control valve on the resin tank with the connected pipes, as well as setting up the relevant parameter, please conduct the trial running as follows:

A. Open the bypass valve, after cleaning the foreign materials in the pipe, close the bypass valve.

B. Fill the brine tank with the planned amount of water and adjust the air check valve. Then add solid salt to the tank and dissolve the salt as much as possible.

C. Switch on power. Press “” and go in the Backwash position; you can hear the sound of air-out from the drain pipeline. After all air is out of pipeline, clean the foreign materials in the resin tank until the outlet water is clean. It will take 8 minutes to finish the whole process.

D. Press “”, turning the position from Backwash to Brine & Slow Rinse; enter in the process of Brine & Slow Rinse. The air check valve close when control valve finished sucking brine, then slow rinse start to work. It is about 60~65 minutes for whole process.

E. Press “”, turning the position from Brine & Slow Rinse to Fast Rinse; enter in the process of Fast Rinse. After brine tank is being refilled with water to the required level. It takes about 4 minutes, and then adds solid salt to the brine tank.

F. Press “”, repeating C, D and E, make the other resin tank run Backwash, Brine & Slow Rinse and Fast Rinse in turn.

G. Press “”, finishing Fast Rinse, making the control valve turn to the two tanks above that finish regeneration in serial Service, and make the other tank in regeneration -- Backwash, Brine & Slow Rinse, Brine Refill, Standby and Fast Rinse in turn.



(If the outlet water is unqualified, turn to Fast Rinse before change tank.)

H. When in Brine Refill status, note the brine refill time and adjust and set the brine refill time according to requirement.

Note:

● When the control valve enters into the regeneration status, all program can be finished automatically according to the setting time; if you want one of steps terminated early, you can press “”.

● In the process of trial running, please check the water situation in all position, ensuring there is no resin leakage.

● The time for Backwash, Brine& Slow Rinse, Brine Refill and Fast Rinse position can be set and executed according to the calculation in the formula or suggestions from the control valve suppliers.

### 3.7. Trouble-Shooting

#### A. Control Valve Fault

Problem	Cause	Correction
1. Softener fails to regenerate.	A. Electrical service to unit has been interrupted. B. Regeneration cycles set incorrect. C. Controller is defective. D. Motor fails to work.	A. Assure permanent electrical service (check fuse, plug, pull chain or switch). B. Rest regeneration cycles. C. Replace controller. D. Replace motor.
2. Regeneration time is not correct.	A. Time of Day not set correctly. B. Power failure more than 3 days.	Check program and reset time of day.
3. Softener supply hard water.	A. Bypass valve is open or leaking. B. No salt in brine tank. C. Injector plugged. D. Insufficient water flowing into brine tank. E. Leak at O-ring on riser pipe. F. Internal valve leak. G. Regeneration cycles not correct. H. Shortage of resin. I. Bad quality of feed water or turbine blocked.	A. Close or repair bypass valve. B. Add salt to brine tank and maintain salt level above water level. C. Change or clean injector. D. Check brine tank refill time. E. Make sure riser pipe is not cracked. Check o-ring and tube pilot. F. Change valve body. G. Set correct regeneration cycles in the program. H. Add resin to mineral tank and check whether resin leaks. I. Reduce the inlet turbidity, clean or replace turbine.
4. Softener fails to draw brine.	A. Line pressure is too low. B. Brine line is plugged. C. Brine line is leaking. D. Injector is plugged. E. Internal control leak. F. Drain line is plugged. G. Brine motor defect. H. Sizes of injector and DLFC not match with tank.	A. Increase line pressure. B. Clean brine line. C. Replace brine line. D. Clean or replace new parts. E. Replace valve body. F. Clean drain line flow control. G. Check the brine motor. H. Select correct injector size and DLFC according to the P18 requirements.

5. Unit used too much salt.	A. Improper salt setting. B. Excessive water in brine tank.	A. Check salt usage and salt setting. B. See problem no.6.
6. Excessive water in brine tank.	A. Overlong refilling time. B. Too much water left after brine draw. C. Foreign material in brine line. D. Power outage when brining and system without liquid level controller. E. Brine refill out control.	A. Reset correct refilling time. B. Check injector and brine line make sure no jet. C. Clean brine valve and brine line. D. Stop water supplying and equip the liquid level controller. E. Repair or replace liquid level controller.
7. Pressure lost or iron in conditioned water.	A. Iron in the water supply pipe. B. Iron mass in the softener. C. Fouled resin bed. D. Too much iron in the raw water.	A. Clean the water supply pipe. B. Clean valve and add resin cleaning chemical, increase frequency of regeneration. C. Check backwash, brine draw and brine tank refill. Increase frequency of regeneration and backwash time. D. Iron removal equipment is required to install before softening.
8. Loss of mineral through drain line.	A. Air in water system. B. Bottom strainer broken. C. Improperly sized drain line control.	A. Assure that well system has proper air eliminator control. B. Replace new bottom strainer. C. Check for proper drain rate.
9. Control cycle continuously.	A. Locating signal wiring breakdown. B. Controller is faulty. C. Foreign material stuck the driving gear. D. Time of regeneration steps were set to zero.	A. Check and connect locating signal wiring. B. Replace controller. C. Take out foreign material. D. Check program setting and reset.
10. Drain flows continuously.	A. Internal valve leak. B. When electricity fails to supply, valve stops backwash or rapid rinse position.	A. Check and repair valve body or replace it. B. Adjust valve to service position or turn off bypass valve and restart when electricity supply.
11. Interrupted or irregular brine.	A. Water pressure too low or not stable. B. Injector is plugged or faulty. C. Air in resin tank. D. Floccules in resin tank during backwash.	A. Increase water pressure. B. Clean or replace injector. C. Check and find the reason. D. Clean the floccules in resin tank.
12. Water flow out from drain or brine pipe after regeneration.	A. Foreign material in valve which makes valve can't be closed completely. B. Hard water mixed in valve body. C. Water pressure is too high which result in valve doesn't get the right position.	A. Clean foreign material in valve body. B. Change valve core or sealing ring. C. Reduce water pressure or use pressure release function.
13. Salt water in soften water.	A. Foreign material in injector make it fails to work. B. Brine valve cannot be shut-off. C. Time of rapid rinse too short.	A. Clean and repair injector. B. Repair brine valve and clean it. C. Extend rapid rinse time.
14. Unit capacity decreases.	A. Unit fails to regenerate or regenerate not properly. B. Fouled resin bed. C. Salt setting not proper. D. Softener setting not proper. E. Raw water quality deterioration. F. Turbine of flow meter is stuck.	A. Regenerate according to the correct operation requirement. B. Increase backwash flow rate and time, clean or change resin. C. Readjust brine drawing time. D. According to the test of outlet water, recount and reset. E. Regenerate unit by manual temporary, then reset regeneration cycle. F. Disassemble flow meter and clean it or replace a new turbine.



**B. Controller Fault**

Problem	Cause	Correction
1.Display abnormal	A.Wiring of front panel with controller fails to work. B. Control board is faulty. C. Transformer damaged. D. Electrical service not stable.	A.Check and replace the wiring. B. Replace control board. C.Check and replace transformer. D.Check and adjust electrical service.
2.No display on front panel	A. Wiring of front panel with controller fails to work. B. Front panel damaged. C. Control board damaged. D. Electricity is interrupted.	A. Check and replace wiring. B. Replace front panel. C. Replace control board. D. Check electricity.
3.E11 Flash	A. Wiring of locating board in regeneration valve with controller fails to work. B. Locating board regeneration valve damaged. C. Mechanical driven failure. D. Faulty control board. E. Wiring of motor with controller regeneration valve is fault. F. Motor regeneration valve damaged.	A.Replace wiring in regeneration valve. B. Replace locating board in regeneration valve. C.Check and repair mechanical part. D. Replace control board. E.Replace motor in regeneration valve F.Replace motor in regeneration valve.
4.E21 Flash	A. Wiring of locating board in main valve with controller fails to work. B. Locating board main valve damaged. C. Mechanical driven failure. D. Faulty control board. E. Wiring of motor with controller main valve is fault. F. Motor main valve damaged.	A.Replace wiring in main valve. B. Replace locating board in main valve. C.Check and repair mechanical part. D. Replace control board. E.Replace motor in main valve. F.Replace motor in main valve.
5.E12 Flash	A.Locating board regeneration valve damaged. B. Wiring of locating board in regeneration valve with controller fails to work. C. Faulty control board.	A. Replace locating board in regeneration valve. B.Replace wiring in regeneration valve. C. Replace control board
6.E3 or E4 Flash	A. Control board is faulty.	A. Replace control board.

**3.8.Assembly & Parts**

1).Construction figure of F118A and F118B:

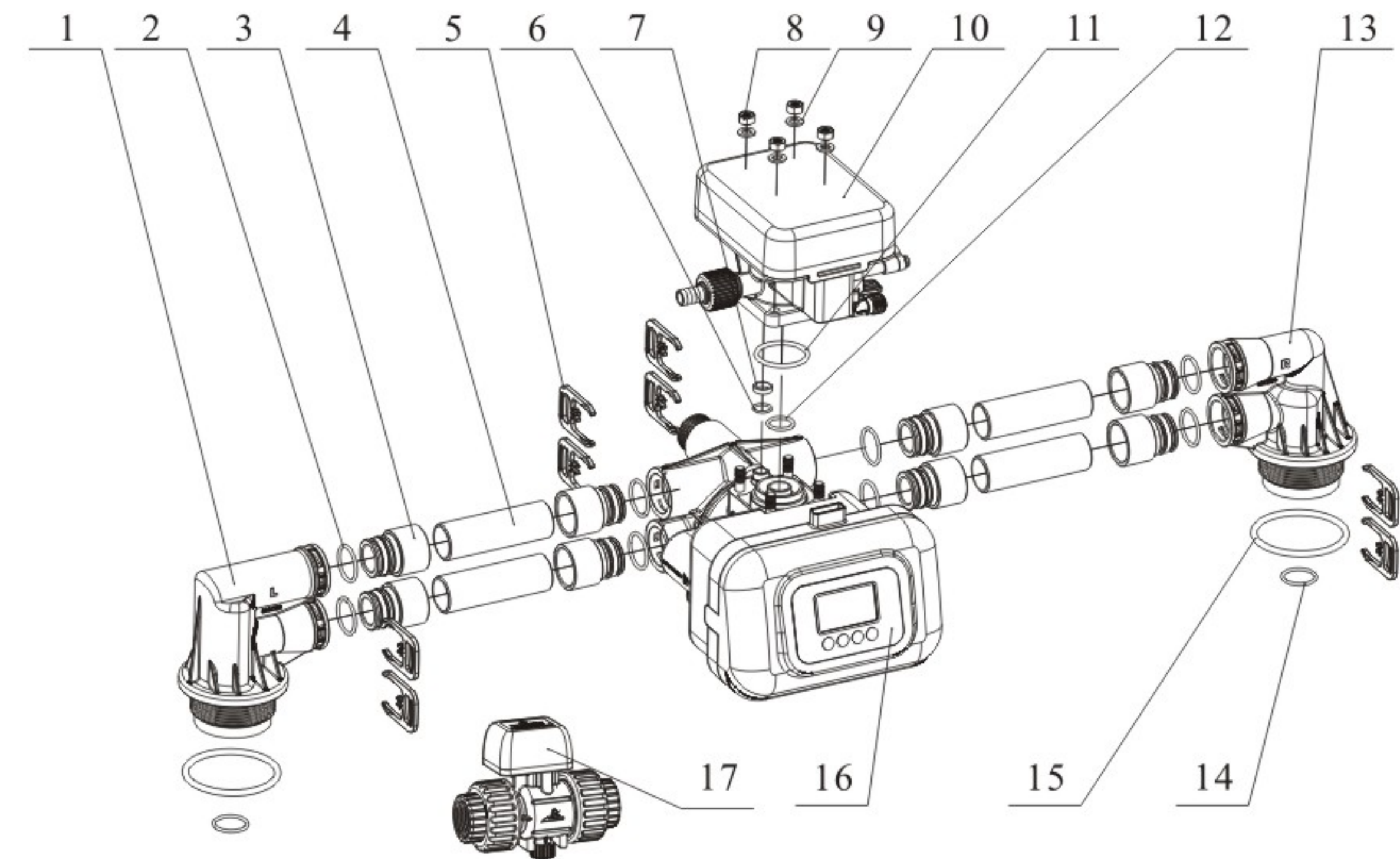

Spare parts and part no.:

Item No.	Description	Part no.	Quantity
1	Valve Body of L Tank (Remark L)	5022111	1
2	O-ring	8378081	8
3	Connector	8458207	8
4	Connecting Pipe	8457119	4
5	Clip	8270004	8
6	O-ring	8378265	1
7	Toggle	8109092	1
8	Hexagonal Nut	8940021	4
9	Washer	8952013	4
10	Regeneration Valve		1
11	O-ring	8378285	1
12	O-ring	8378074	1
13	Valve Body of R Tank (Remark R)	5022112	1
14	O-ring	8378078	2
15	O-ring	8378143	2
16	Main Valve		1
17	F118B Electronic Ball Valve for Regeneration with Soft Water	6922028	1



2).Construction figure of F118AR and F118BR:

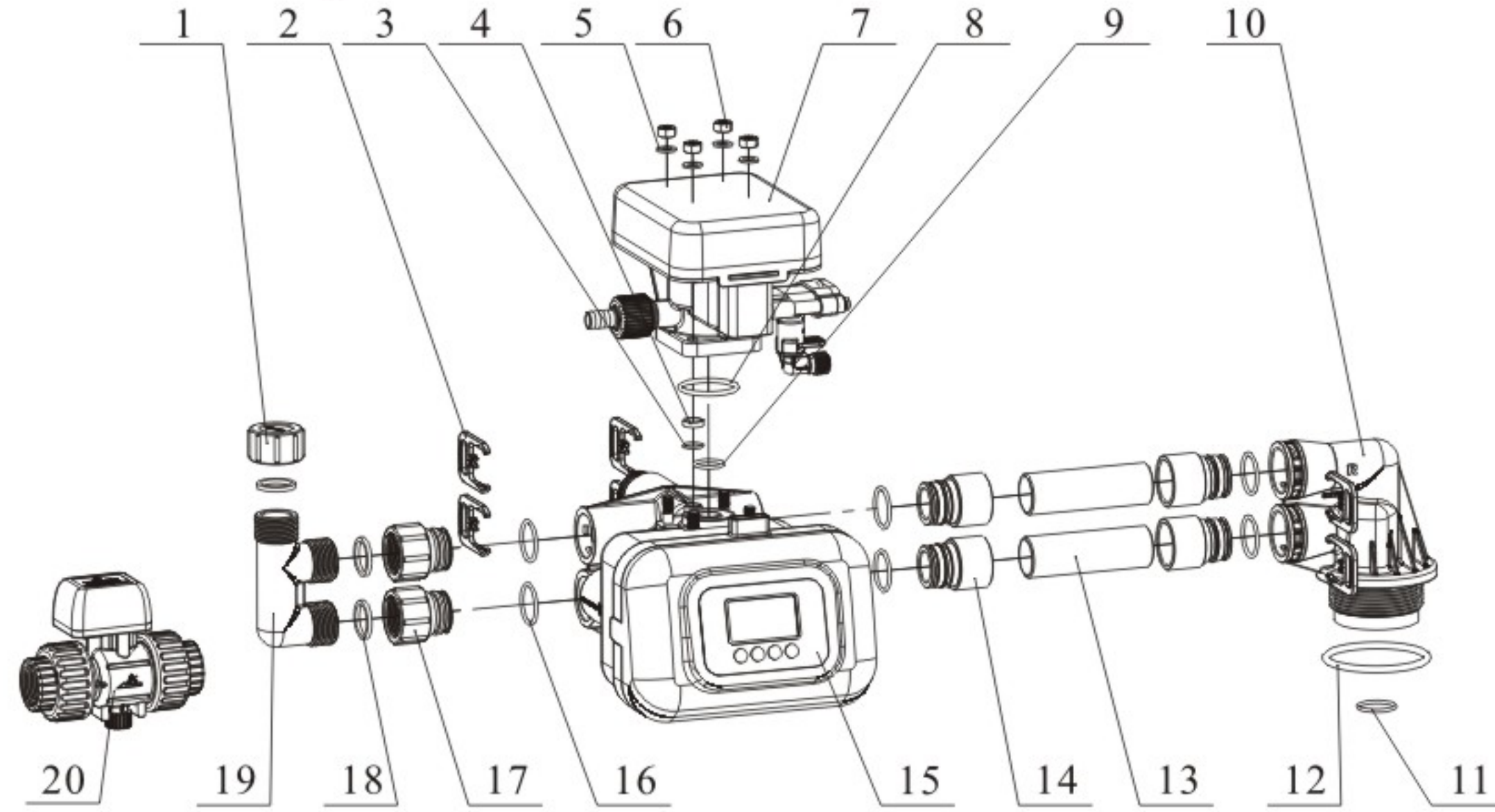

Spare parts and part no.:

Item No.	Description	Part no.	Quantity
1	Blind Hole Nut	8945002	1
2	Clip	8270004	6
3	O-ring	8378265	1
4	Toggle	8109092	1
5	Washer	8952013	4
6	Hexagonal Nut	8940021	4
7	Regeneration Valve		1
8	O-ring	8378285	1
9	O-ring	8378074	1
10	Valve Body of R Tank (Remark R)	5022112	1
11	O-ring	8378078	1
12	O-ring	8378143	1
13	Connecting Pipe	8457119	2
14	Connector	8458207	4
15	Main Valve		1
16	O-ring	8378081	6
17	Animated Nut	8945001	2
18	Seal Ring	8371001	3
19	Connector	8458208	1
20	F118BR Electronic Ball Valve for Regeneration with Soft Water	6922028	1

3).Construction figure of main valve:

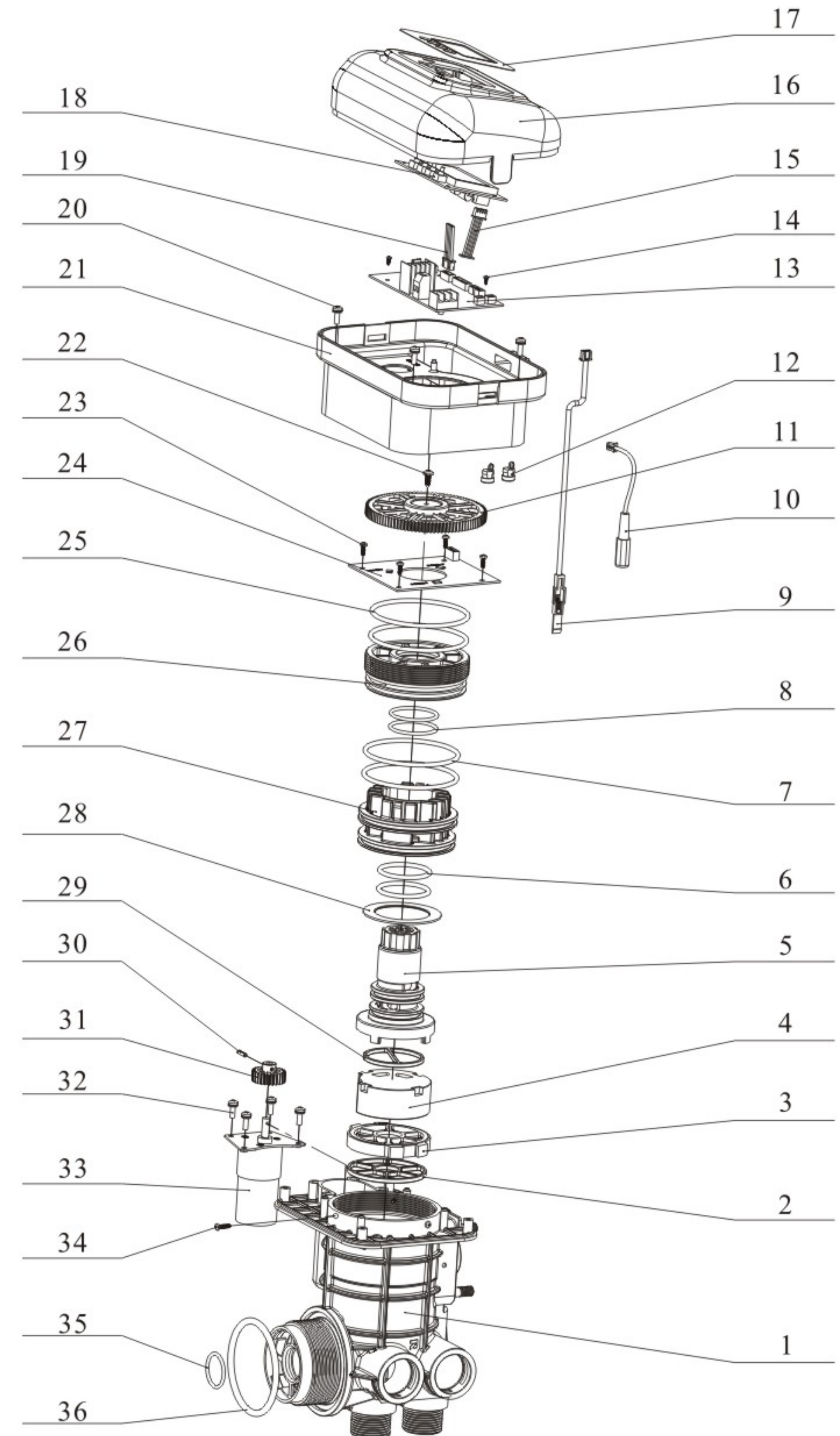



Spare parts and part no.:

Item No.	Description	Part no.	Quantity
1	Valve body	5022109	1
2	Seal Ring	8370113	1
3	Fixed Disk	8469081	1
4	Moving Disk	8459080	1
5	Shaft	8258044	1
6	O-ring	8378184	2
7	O-ring	8378222	2
8	O-ring	8378087	2
9	Probe Wire	6386016	1
10	Wire for Power	5513003	1
11	Gear	5241002	1
12	Cable Clip	8126004	2
13	Main Control Board	6382112	1
14	Screw, Cross	8909004	2
15	Wire for Display Board	5512002	1
16	Front Cover	8300050	1
17	Label	8865072	1
18	Display Board	6381006	1
19	Wiring of Locating Board	5511025	1
20	Screw, Cross	8902005	4
21	Dust Cover	8005068	1
22	Screw, Cross	8909013	1
23	Screw, Cross	8909008	4
24	Locating Board	6380046	1
25	O-ring	8378217	2
26	Fitting Nut	8092051	1
27	Chamber Set	8330005	1
28	Anti-friction Washer	8216034	1
29	Seal Ring	8370114	1
30	Spring Washer	8993003	1
31	Small Gear	8241003	1
32	Screw, Cross	8902005	4
33	Motor	6158060	1
34	Screw, Cross	8909023	3
35	O-ring	8378078	1
36	O-ring	8378143	1

4).Construction figure of regeneration valve:

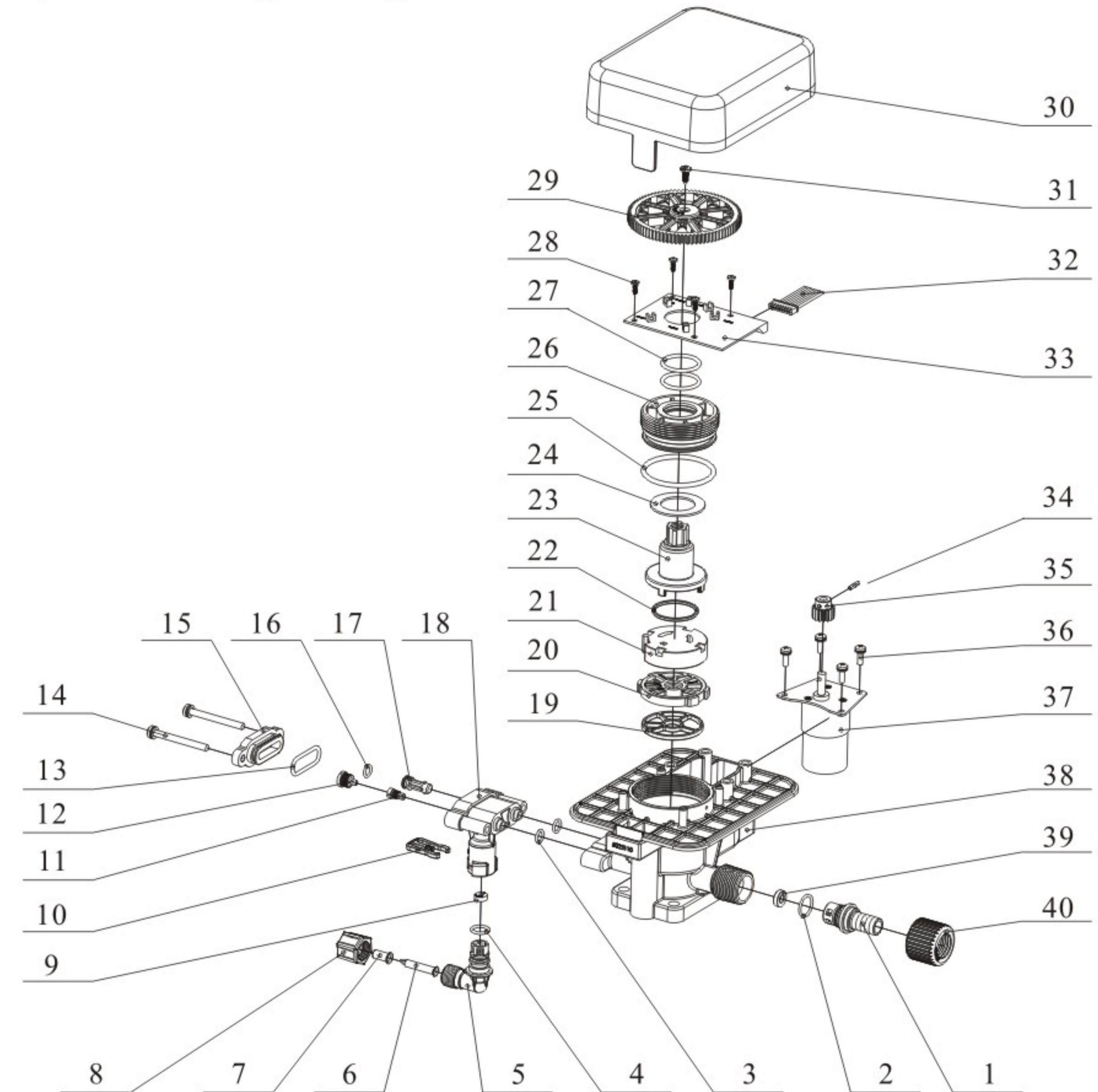

Spare parts and part no.:

Item No.	Description	Part no.	Quantity
1	Connector	8458064	1
2	O-ring	8378179	1
3	O-ring	8378016	2
4	O-ring	8378169	1
5	Connector	8458073	1
6	Filter Net	8336008	1
7	Tube	8457039	1
8	Hexagonal Nut	8940001	1



9	Brine Line Flow Control (Standard)	8468052	1
10	Clip	8270010	1
11	Throat Injector (Standard)	8467009	1
12	Nozzle, Injector (Standard)	8454010	1
13	O-ring	8378234	1
14	Screw, Cross	8902062	2
15	Cover, Injector	8315087	1
16	O-ring	8378015	1
17	Filter Net	5336008	1
18	Injector Body	8008014	1
19	Seal Ring	8370115	1
20	Fixed Disk	8469082	1
21	Moving Disk	8459081	1
22	Moving Seal Ring	8370053	
23	Shaft	8258009	1
24	Anti-friction Washer	8216010	1
25	O-ring	8378107	1
26	Fitting Nut	8092007	1
27	O-ring	8378078	2
28	Screw, Cross	8909008	4
29	Gear	8241044	1
30	Dust Cover	8005069	1
31	Screw, Cross	8909013	1
32	Wiring of Locating Board	5511005	1
33	Locating Board	6380047	1
34	Spring Washer	8993003	1
35	Gear	8241010	1
36	Screw, Cross	8902005	4
37	Motor	6158064	1
38	Valve Body	5022110	1
39	Drain Line Flow Control (Standard)	8468062	1
40	Animated Nut	8945025	1

## 4. Warranty Card

Dear client:

This warranty card is the guarantee proof of RUNXIN brand multi-functional flow control valve. It is kept by client self. You could get the after-sales services from the supplier which is appointed by RUNXIN manufacturer. Please keep it properly. It couldn't be retrieved if lost.

1. Guarantee period expired. (One year)
2. Damage resulting from using, maintenance, and keeping that are not in accordance with the instruction.
3. Damage resulting from repairing not by the appointed maintenance personnel.
4. Content in guarantee proof is unconfirmed with the label on the real good or be altered.
5. Damage resulting from force majeure.

<b>Product Name</b>	 <b>Multi-functional Flow Control Valve for Water Treatment Systems</b>			
<b>Model</b>		<b>Code of Valve Body</b>		
<b>Purchase Company Name</b>		<b>Tel/Cel.</b>		
<b>Problem</b>				
<b>Solution</b>				
<b>Date of Repairing</b>		<b>Date of Accomplishment</b>		<b>Maintenance Man Signature</b>

When product need warranty service, please fill in the below content and sent this card together with the product to the appointed suppliers or Runxin company.

<b>End-user Company Name</b>		<b>Tel/Cel.</b>	
<b>Purchase Company Name</b>		<b>Tel/Cel.</b>	
<b>Model</b>		<b>Code of Valve Body</b>	
<b>Tank size</b> $\phi$ ×	<b>Resin tank size</b> L	<b>Raw water hardness</b> mmol/L	
<b>Water source:</b> ground-water <input type="checkbox"/> tap water <input type="checkbox"/>	<b>Water treatment capacity</b> m <sup>3</sup>	<b>Backwash time</b> min	
<b>Brine Rinse Time</b> min	<b>Slow Rinse Time</b> min	<b>Brine Refill Time</b> min	<b>Fast Rinse Time</b> min
<b>Problem Description</b>			